

CONTROL Pro



NOTE

Keep the operating manual for future use.

ATTENTION

Technical details subject to change!

Quality considerations

The **sera** quality management and quality assurance system is certified according to DIN EN ISO 9001:2015. The **sera** product complies with the applicable safety requirements and accident prevention regulations.

About this manual

Special instructions in this manual are marked with text and symbols.

NOTE

Notes or instructions that make work easier and ensure safe operation.

ATTENTION

Failure to observe these safety instructions may result in malfunctions or damage to property.

WARNING

Failure to observe these safety instructions may result in damage to property and personal injury.



Reference to the instructions of SAFETY INSTRUCTIONS SI01.

TRANSPORT & STORAGE	4
General	4
Storage.....	4
TECHNICAL DATA	5
ELECTRICAL DATA	5
AMBIENT CONDITIONS	5
TEMPERATURE INFORMATION.....	5
Electrical interfaces	6
ELECTRICAL CONNECTIONS	6
OPERATION	9
Navigation.....	9
LED operation indicators	10
Menu.....	11
Operating modes	14
Assignment.....	14
MANUAL operating mode	15
PULSE operating mode	16
ANALOGUE operating mode	17
Input 1 (digital)	18
Input 2.....	18
Outputs 1 and 2 (digital)	18
Pre-alarm, dry run	19
Slow mode (stepper motor pump).....	19
Diaphragm monitoring	20
Calibration of the delivery rate display	20
System.....	21
Password	21
Replacement of the diaphragm	21
Factory settings	22
Messages	22
Settings (parameters)	23
TROUBLESHOOTING / FAULT CLEARANCE	24
MAINTENANCE / DECOMMISSIONING / DISPOSAL	26
Maintenance and cleaning	26
Decommissioning	26
Disposal.....	26
SOFTWARE UPDATE	27

WARNING

Safety instructions must be strictly observed and followed!
See supplementary instructions "SAFETY INSTRUCTIONS".
Man, machine and environment are endangered if the safety instructions are not observed.



General

sera products are checked for faultless condition and function before shipment. The product must be checked for transport damage immediately after receipt. Any discovered damage must be reported immediately to the responsible carrier and the supplier.

Storage

Undamaged packaging ensures protection during subsequent storage and must not be opened until the product is installed. Proper storage increases the service life of the product. Proper storage means protection against negative influences such as heat, humidity, dust, chemicals, etc.

The following storage instructions must be complied with:

- Storage location: cool, dry, dust-free and slightly ventilated.
- For storage temperatures and relative humidity, see chapter "TECHNICAL DATA".
- The maximum storage time in the standard packaging is 12 months.

If these values are exceeded, metal products should be air-sealed in foil and protected against condensation water with a suitable desiccant.

Do not store solvents, fuels, lubricants, chemicals, acids, disinfectants and similar in the storage room.

ELECTRICAL DATA	
Power cable length ▶ Diaphragm pump	3 m
Power cable length ▶ Stepper motor pump	2 m (iSTEP S) 3 m (iSTEP XS)
Input voltage / control input	24 V DC
Minimum contact signal time Minimum interval between pulses	55 ms
Certification	CE, TR

SIGNAL INPUT	
Max. load ▶ Contact input in the digital mode	30 V DC
Max. load ▶ Analogue input	24 mA
Impedance at 4-20 mA ▶ Analogue input	< 200 Ω
Max. line resistance ▶ Empty / Pre-empty signal	4K Ω
Max. line resistance ▶ Contact signal circuit	100K Ω
Sampling rate	1 ms

AMBIENT CONDITIONS	
Max. relative humidity	90%

TEMPERATURE INFORMATION	
Max. operating temperature	40 °C
Min. operating temperature	0 °C
Max. storage temperature	40 °C
Min. storage temperature	0 °C

ELECTRICAL CONNECTIONS



WARNING

Safety instructions must be strictly observed and followed!
See supplementary instructions "SAFETY INSTRUCTIONS".
Man, machine and environment are endangered if the safety instructions are not observed.



Electrical interfaces

The controller has 2 interfaces:



No.	Interface	Assignment	Function
1	External control	8-pole	Control inputs / control outputs
2	Level connection	8-pole	Pre-alarm and dry running protection.

External control (1)

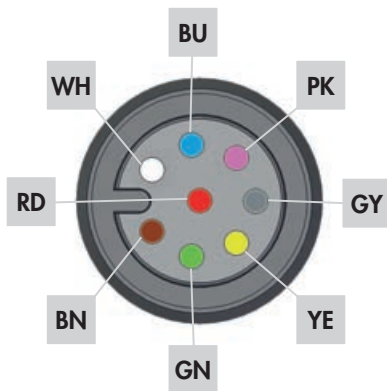

All inputs and outputs can be freely parametrised.



ATTENTION

To avoid damaging the pump, perform parametrisation of the inputs and outputs before connecting the control cable.



NOTE

The following must be observed when replacing a C409.2 Pro for C409.2:
Changed factory settings of the input configuration for the input 2.

Pin Assignment			Function	Pin
WH	(white)	Input 1	Pulse	Pin 1
BN	(brown)	Input 2	External stop	Pin 2
GN	(green)	Input 3	Analogue	Pin 3
YE	(yellow)	24 V external	24 V external	Pin 4
GY	(grey)	Output 1	Ready to run	Pin 5
PK	(pink)	Output 2	Stroke signal	Pin 6
BU	(blue)			Pin 7
RD	(red)	Ground	Ground	Pin 8

ELECTRICAL CONNECTIONS

Assignment

Connection of a pulse signal with External Stop (internal control voltage):

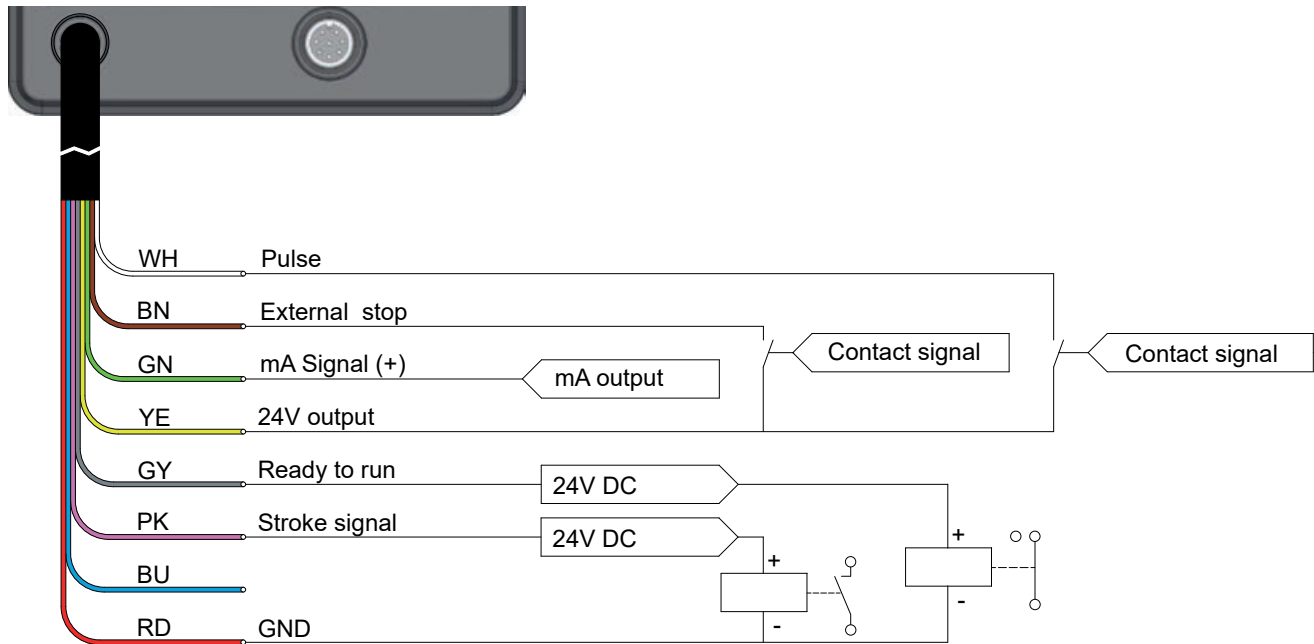

Connection of a pulse signal with External Stop (external control voltage / PLC):

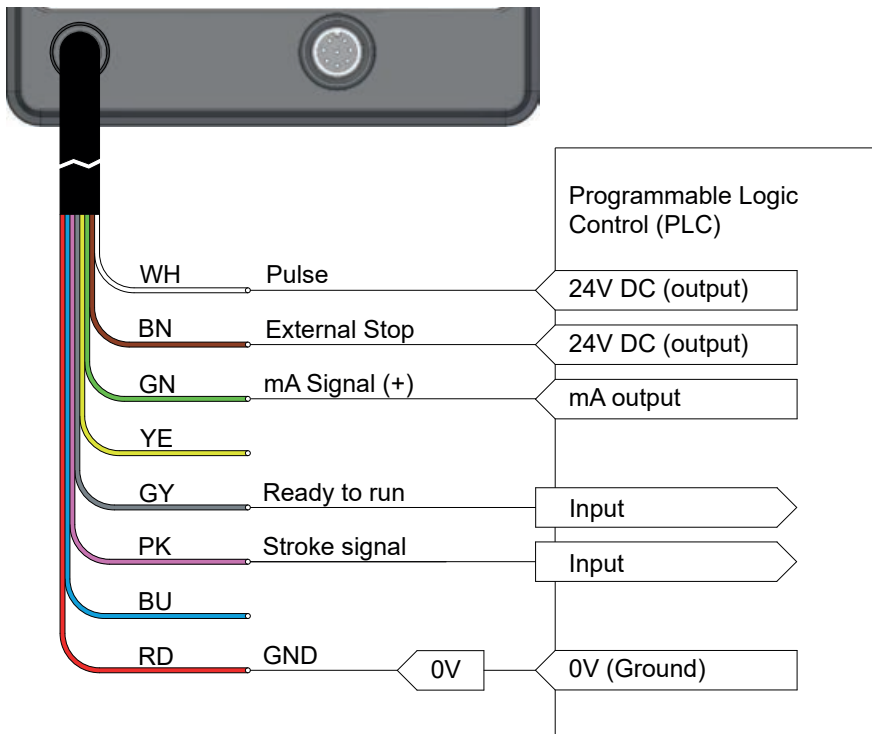

Level connection (2)

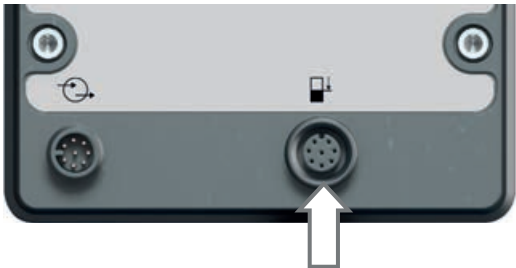
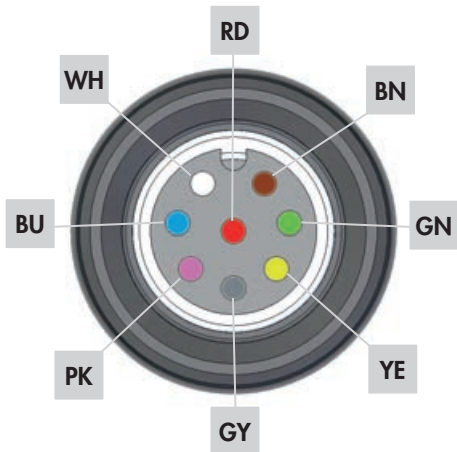

Wire colour	Function	Pin
PK (pink)	Pre-alarm level	Pin 6
BU (blue)	Dry run	Pin 7
RD (red)	Ground	Pin 8

The inputs can be switched using a floating contact signal.
 Pre-alarm and dry running are set to normally open floating contacts at the factory.
 The sockets of the connections are A-coded and the assignments of the functions are symbolically labelled.

Assignment

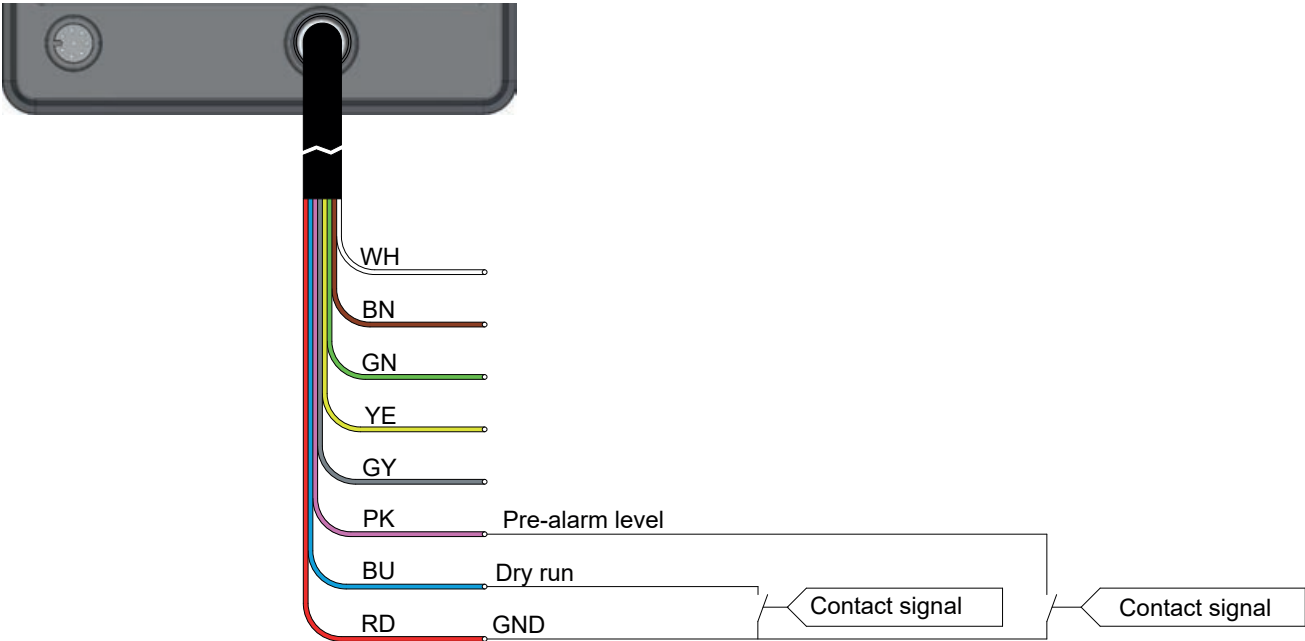

Suction lances connection

In order to connect the pump to a **sera** suction lance, an 8-pole cable connector with M12 thread is needed (accessory part number: 90042494 (1) or 90022885 (2)).

This cable connector is connected to the level input of the controller.

Suction lances with the pre-assembled cable connector ► see **sera** product catalogue.



Navigation



DISPLAY SYMBOLS		
Operating mode Manual		
Operating mode Pulse		
Operating mode Analogue		
Status	Pause	
Status	External stop	
Status	Suction stroke	
Status	Pressure stroke	
Status	Alarm	
Menu	Settings	
Slow Mode	Slow Mode active	[S]
Stroke frequency (1) or Delivery rate (1)	0.1% ... 100.0% 0.150 l/h ... 15.000 l/h (calibrated 15 l/h)	

	START/STOP	ENTER	UP	DOWN
Back				
Start/Stop				
Select				
Confirm warning				
Suction mode - venting (pump active)				
Change menu or value				
Change menu or value				
Restart pump				

tap briefly

tap and hold for 1 s

tap and hold for 3 s

OPERATION

WARNING

Safety instructions must be strictly observed and followed!
See supplementary instructions "SAFETY INSTRUCTIONS".
Man, machine and environment are endangered if the safety instructions are not observed.



ATTENTION

The pump restarts in the selected operating mode after the power supply was switched on or a power supply recovery following a mains failure!

ATTENTION

Switching the voltage supply on and off temporarily is to be avoided!
A waiting time of at least two minutes must be observed between switching the pump off and on again!

ATTENTION

Only operate the pump when it is connected to an earthed power supply!

LED operation indicators

Overview of operation indicators	blue	green	yellow	red
Ready	x			
Pump active		x		
Internal error				x
Mains voltage too low / too high				x
Level monitoring:				
Level pre-alarm – pump in operation		flashing	flashing	
Level pre-alarm – pump stopped			x	
Dry run				x
Diaphragm monitoring (manual acknowledgement)				
Diaphragm rupture				x
Analogue operation				
mA signal < 3.5 mA				x
mA signal > 20.5 mA				x
Service				
Order service kit / pump active		flashing	flashing	
Order service kit / pump not active			x	
Stroke (manual acknowledgement)				
Step loss		flashing	flashing	
No stroke detection				x

Menu

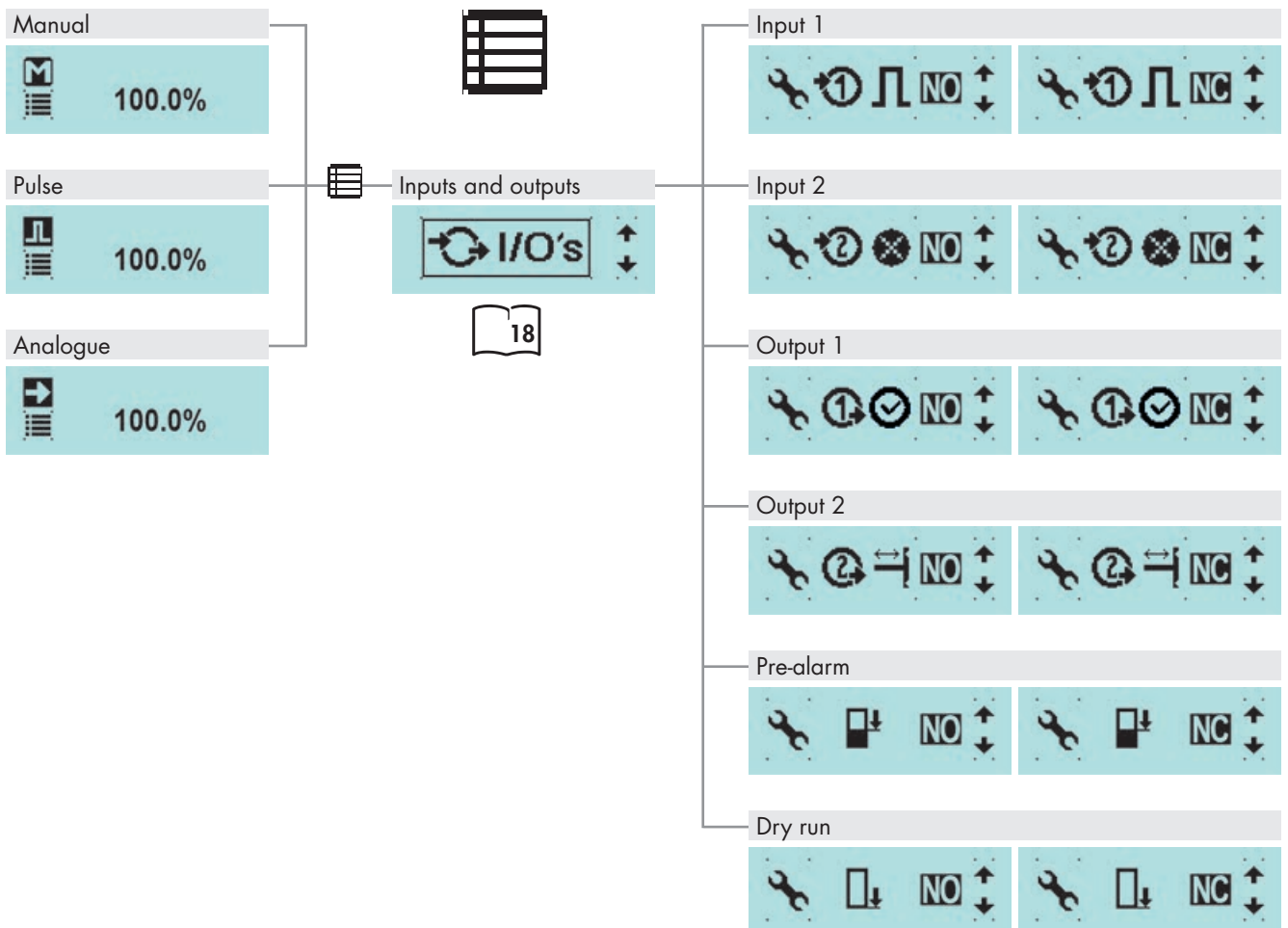
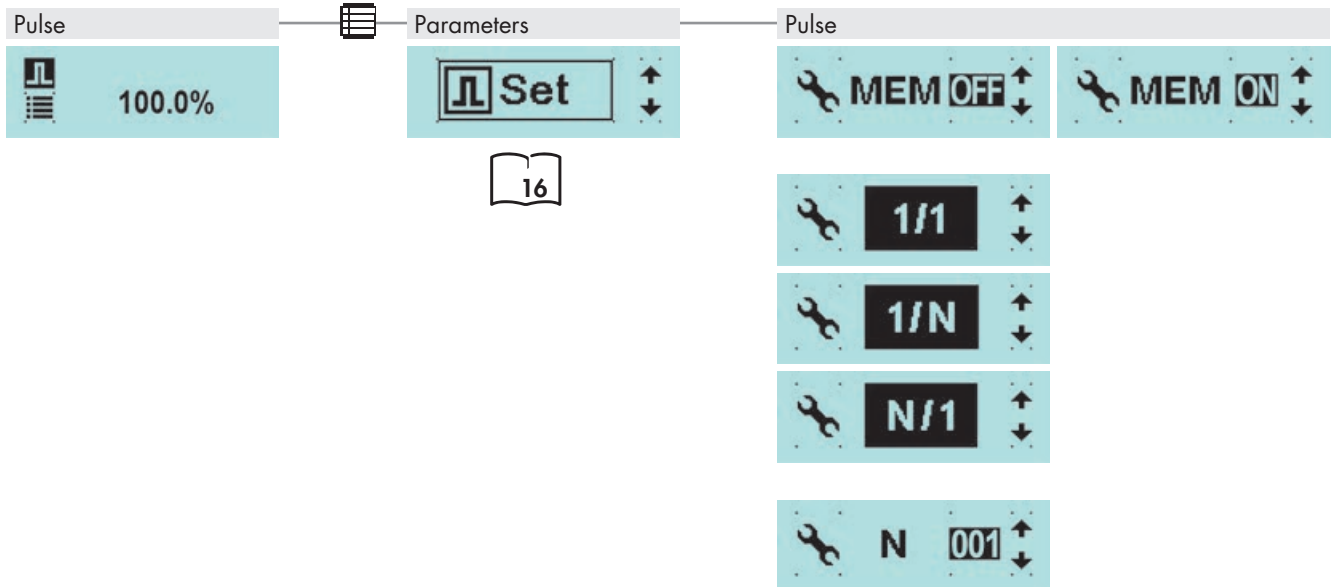

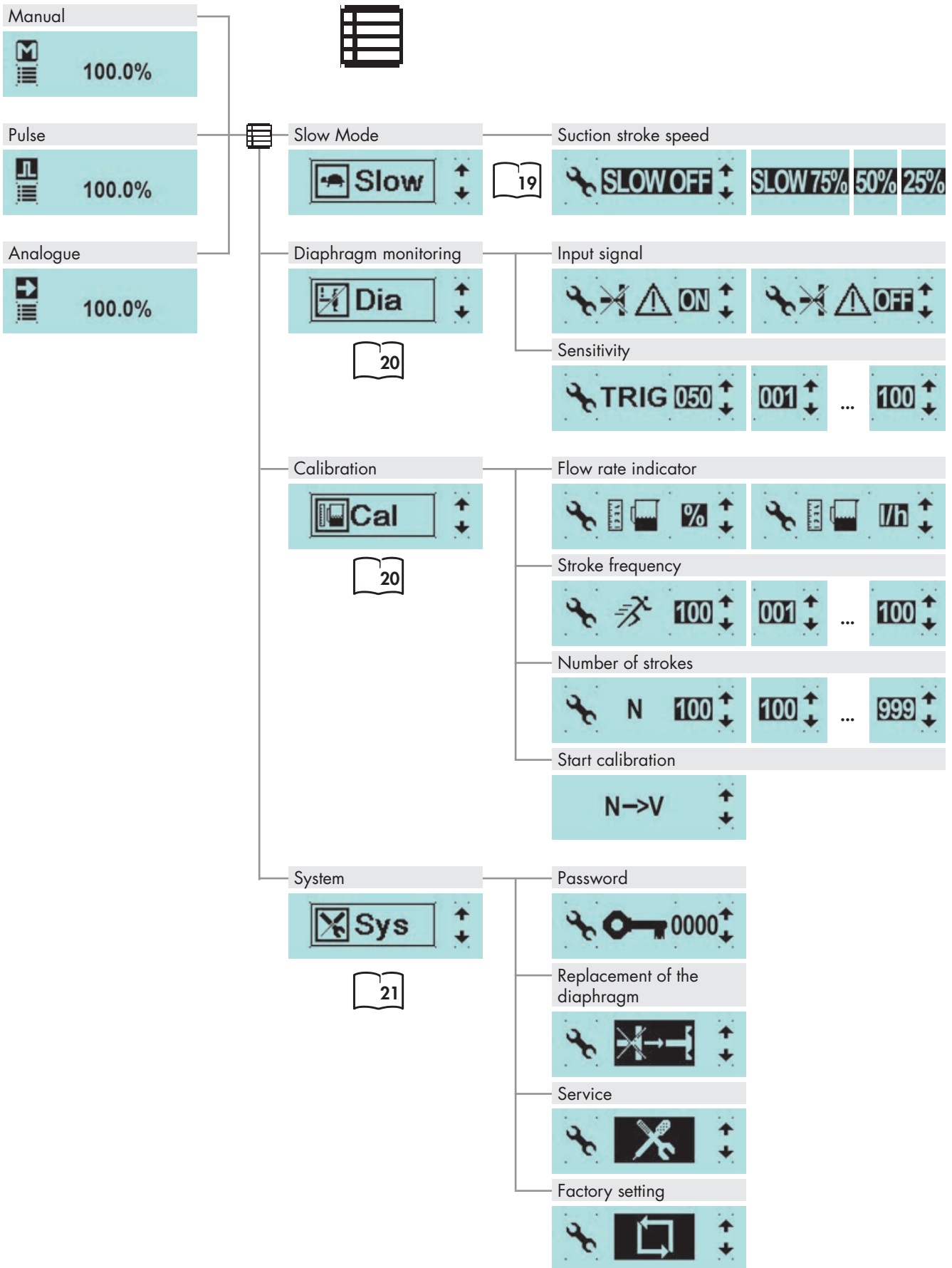

OPERATION

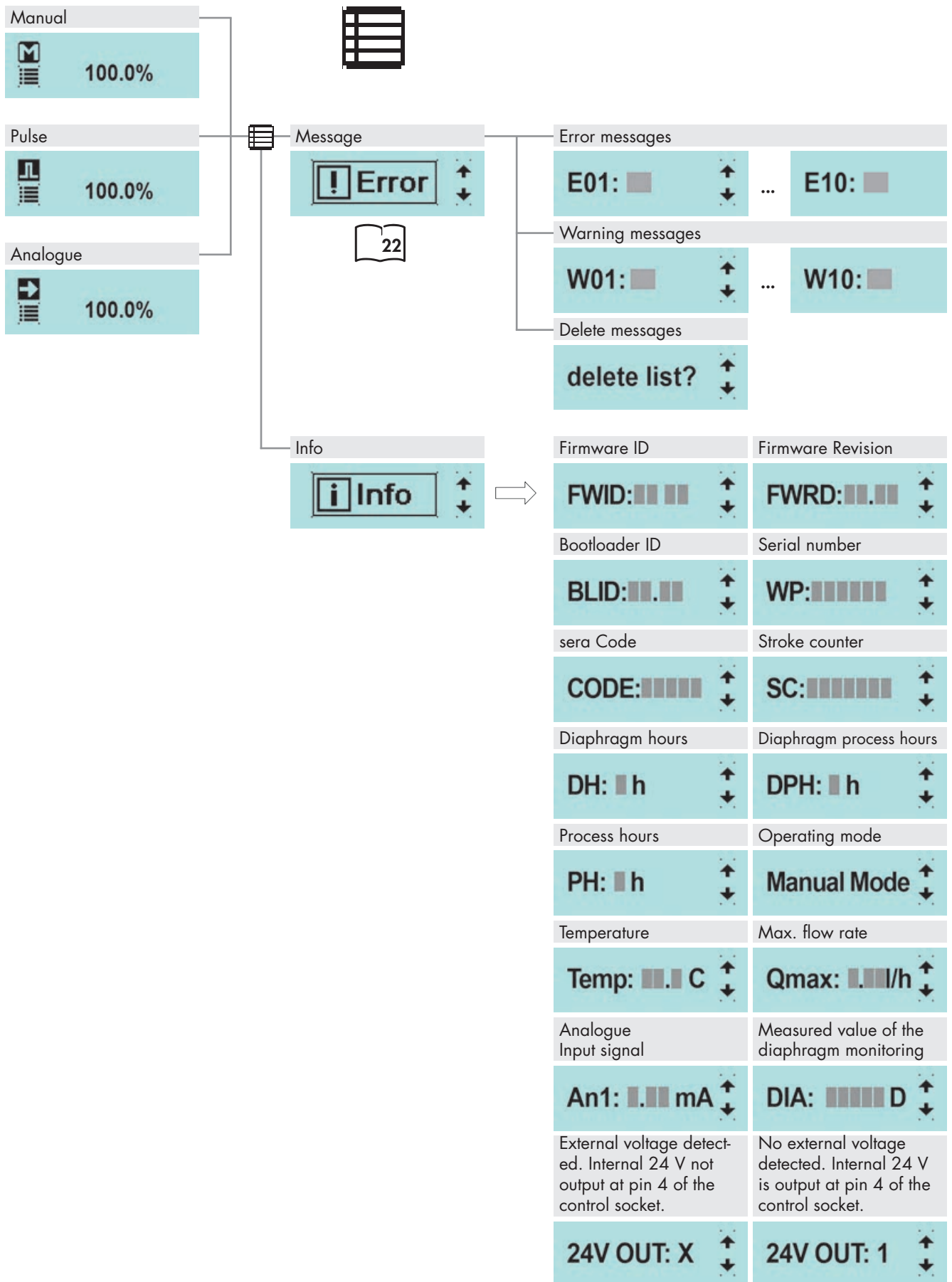



Operating modes

You can select between five different operating modes:

MANUAL	Local operation and control of the pump without external control. The flow rate can be set by specifying a stroke frequency. With a calibrated pump, the flow rate is set in l/h instead of via the stroke frequency in %.	 100.0%
PULSE	The pump can be operated using incoming pulses with transmission, reduction or 1/1.	 100.0%
ANALOGUE	The stroke frequency of the pump is controlled via the received analogue signal.	 100.0%

MANUAL operating mode

Standard adjustment of the delivery rate is via the stroke frequency:

- 0-100% in 0.1% steps ► Stepper motor pump
- 0-100% in 1% steps ► Diaphragm pump (409.2)

After calibration, the flow rate is entered in the display as a setpoint in l/h or ml/h instead of by stroke frequency in %- (see "Calibration of the delivery rate display" on page 20). In the Operating Messages view, the stroke frequency display is replaced by the flow rate display. The total delivery volume is also still indicated in litres.

NOTE

In the –PARAMETERS– menu, there are no setting options for the MANUAL operating mode.

PULSE operating mode

ATTENTION

The maximum load capacity of the control inputs and outputs is:

Inputs: 30 V DC
Outputs: 30V / 30 mA

ATTENTION

The connection pin Output + / Signal + (wire colour: yellow) is not protected against short circuit! In the event of a short circuit, there is the danger of damage to the control electronics!
Therefore, it must be strictly ensured that the 24 V output connection is not directly connected to other connections.

ATTENTION

To avoid damaging the pump, perform parametrisation of the inputs and outputs before connecting the control cable.

There are 4 operating modes for the pulse operation:

- **Reduction**
In this mode, a reduction of the received pulses is performed. This means that the pump will only perform a stroke after an adjustable number of pulses (reduction factor) has been received.
- **Transmission**
In this mode, a transmission of the received pulses is performed. This means that the pump will perform an adjustable number of strokes (transmission factor) after each received pulse.
- **1/1**
In this mode, the pump performs exactly one stroke for each received pulse.

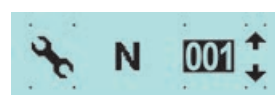

Selecting the PULSE FACTOR

Depending on the selected pulse mode, the pulse factor corresponds either to the reduction factor or the transmission factor.

The **reduction** factor can be selected between 1 and 999. For example, if a reduction factor of 50 is selected, then the pump will only perform a stroke with every 50th received pulse.

The **transmission** factor can be selected between 1 and 999. For example, if a transmission factor of 50 is selected, then the pump will perform 50 strokes with every received pulse.

Switching the PULSE MEMORY ON/OFF

The pump is equipped with a pulse memory, which can optionally be switched ON and OFF.

A maximum of 999 strokes can be saved.

If the number of received pulses exceeds the number that can be handled by the pump, then the pulses will be buffered and the strokes will be performed later.

ANALOGUE operating mode

⚠ ATTENTION

To avoid damaging the pump, perform parametrisation of the inputs and outputs before connecting the control cable.

i NOTE

Hysteresis

The controller starts dosing at a stroke frequency of 0.5% and stops the dosing process at 0.0% stroke frequency.

4-20 mA

A signal with a control current of 4mA corresponds to 0 % stroke frequency; a signal with 20 mA corresponds to 100 % stroke frequency. In this range, the stroke frequency behaves proportionally to the control current (see following figure).

If the input signal is < 3.5 mA, the pump outputs an error code for an analogue signal < 4 mA. Thus, a wire break (control current = 0 mA) can be detected. If the input signal is > 20.5 mA, the pump stops and the error code for the analogue signal > 20 mA is output.

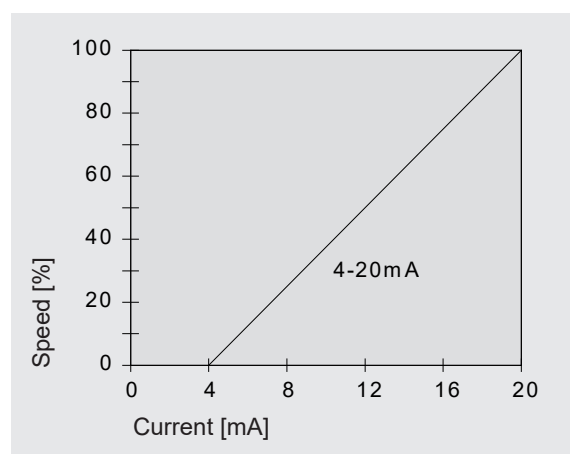

Input 1 (digital)

- **Pulse**
Configuration of the input as pulse input

Contact

NO / NC contact - Configuration of the contact type (NO or NC contact).

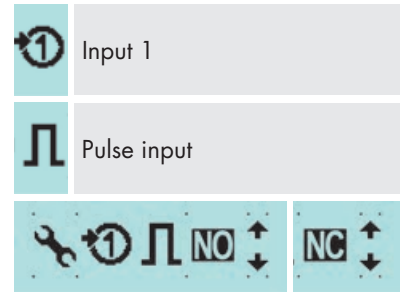

Input 2

- **External Stop**
Function for stopping the pump externally.

i NOTE

The External Stop symbol is shown in the display if the pump is stopped using External Stop.

Contact

NO / NC contact - Configuration of the contact type (NO or NC contact).



⚠ ATTENTION

To avoid damaging the pump, perform parametrisation of the inputs and outputs before connecting the control cable.

Outputs 1 and 2 (digital)

- **Ready to run**
Signal for operational readiness of the pump.
- **Stroke signal**
Message when a stroke is executed.

Contact

NO / NC contact - Configuration of the contact type (NO or NC contact).

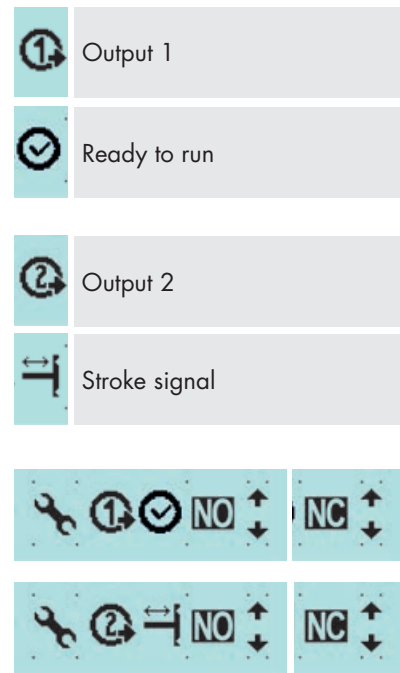

Pre-alarm, dry run

The connection of a **sera** suction lance enables the monitoring of the fill level of the dosing tank:

Settings can be made for the following items:

- Pre-alarm
- Dry run

Configuration of the two level inputs. You can choose between switching off (OFF) the input or configuring the input as NORMALLY CLOSED (= floating opening NO) or NORMALLY OPEN (= floating closing NC).

The factory setting for both level inputs is NORMALLY OPEN



Configuration	Pre-alarm	Dry run
1	NC	NC
2	NC	NO
3	NO	NO

• Configuration 1

This configuration is preset at the factory. A 1-stage or 2-stage level monitor with floating normally open contacts (pre-alarm + dry run or only dry run) can be connected.

• Configuration 2

This configuration must be selected if a 1-stage level monitor (dry run only) with floating normally closed contact is connected.

• Configuration 3

This configuration must be selected if a 2-stage level monitor with floating normally closed contacts (pre-alarm + dry run) is connected.

Slow mode (stepper motor pump)

In Slow mode, the pump is operated at reduced speed in the suction stroke.

This is useful, for example, when pumping highly viscous media.

The speed of the suction stroke can be set to 75, 50 or 25% of the normal suction stroke speed.

Due to the reduced suction stroke speed, the maximum configurable delivery rate reduces (see "Technical Data" in the operating manual of the pump).

The Slow Mode symbol is shown on the Home display.

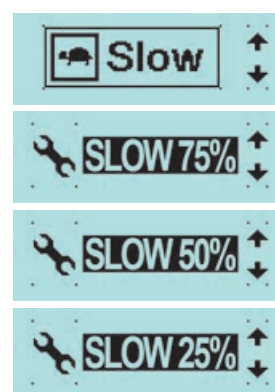

Diaphragm monitoring

Diaphragm monitoring is installed in every pump. It is used for monitoring the delivery diaphragm.

The following items can be adjusted:

- INPUT SIGNAL**

Selection between switch-off (OFF) of the diaphragm monitoring and a configuration as NO contact (for diaphragm pumps "e" and stepper motor pumps or NC contact (for diaphragm pumps "ML" and "KM").

- SENSITIVITY**

Input of the sensitivity of the diaphragm rupture monitoring in percent. For pumps with a diaphragm rupture electrode DRD, an adjustment to the conductivity of the pumped medium is possible. In the case of poorly conductive media, the sensitivity must be set to a high value (e.g. 100% at approx. 4 µS/cm). The sensitivity of ML and KM pumps must not be adjusted.



i NOTE

The sensitivity is set to 50% at the factory. This corresponds to a minimum conductivity of the dosing medium of approx. 45 µS/cm. The minimum conductivity at 100% sensitivity is 5 µS/cm.

Calibration of the delivery rate display

The calibration is used to activate the flow rate indicator.

Calibration procedure

- Lead the suction line into a calibration pot filled with the dosing medium – the pressure line must be installed in final position, i.e. the pump works under operating conditions.
- When the suction pipe is empty, the dosing medium must be drawn in (MANUAL operating mode, keep the pump running).
- Note the fill level in the calibration pot (= base quantity).
- Select the Calibration (Cal.) menu item under Settings.
- First, enter the required number of strokes (**at least 200!**). The higher the number of strokes, the more accurate is the calibration!
- Enter frequency at which the pump should be operated later (10...100%).
- Set stroke length at which the pump is to be operated (20...100%)
- Select Start Calibration to start the calibration.
- The dosing pump performs the specified number of strokes (wait for process).
- Determination of the delivered quantity (= difference between base quantity and remaining quantity in the calibration pot).
- Input of the determined delivered quantity (measured value).

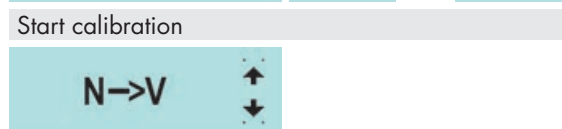
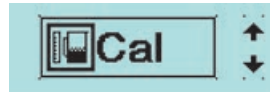

i NOTE

For pumps of the C409.2/C410.2 series, a stroke length deviation of +/-15% of the calibrated value and below a stroke length of 20% will cause the warning E...:128 „calibration range exceeded“ to be displayed. Below a stroke length of 20%, this warning may be followed by the error message W...:128 „no stroke detection“. The pump is stopped.

Standard flow rate indicator

With the standard flow rate indicator, the entered target value is converted into the corresponding stroke frequency.

Internal calculation:

100% stroke frequency > calibrated: 10l/h

Setpoint: 8 l/h > 80% stroke frequency

System

- Select "System".

The system settings are independent of the operating mode.

- Password
- Replacement of the diaphragm
- Service
- Factory setting

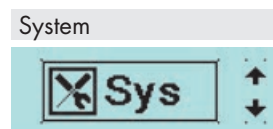

Password

Two password levels are provided to increase the operating safety.

The password consists of a four-digit numeric code and is freely selectable.

The setting of the flow rate, the operating mode and the settings in the menu can be protected with a password.

This password can be activated and deactivated. The password (0000) is deactivated at the factory.

Reset password:

- Set the numeric code 0000.
- Or restart by unplugging the mains plug.
The password is active after restart or during operation after 30 s. Thus, the password can be changed after the restart.

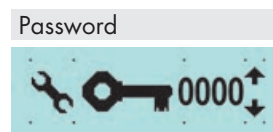

Replacement of the diaphragm

A warning message prompting to order the service kit is displayed after 2500 hours of operation. The pump can continue to be operated after the warning message has been acknowledged.

i NOTE
After acknowledgement, the warning message repeats after 48 hours.

A warning message prompting to replace the service kit is displayed after 3000 hours of operation. The pump can continue to be operated after the warning message has been acknowledged.

i NOTE
If the warning message is acknowledged without replacement, the warning message repeats after 24 hours.

Replacement of the diaphragm

W01:4

Order service kit!

W02:8

see
"Spare and
wear parts"
Operating Manual
of the pump

Pre-alarm level

W03:1

Change diaphragm

The diaphragm must be replaced if the Service message occurs.
The menu specifies the following procedure for the pump:

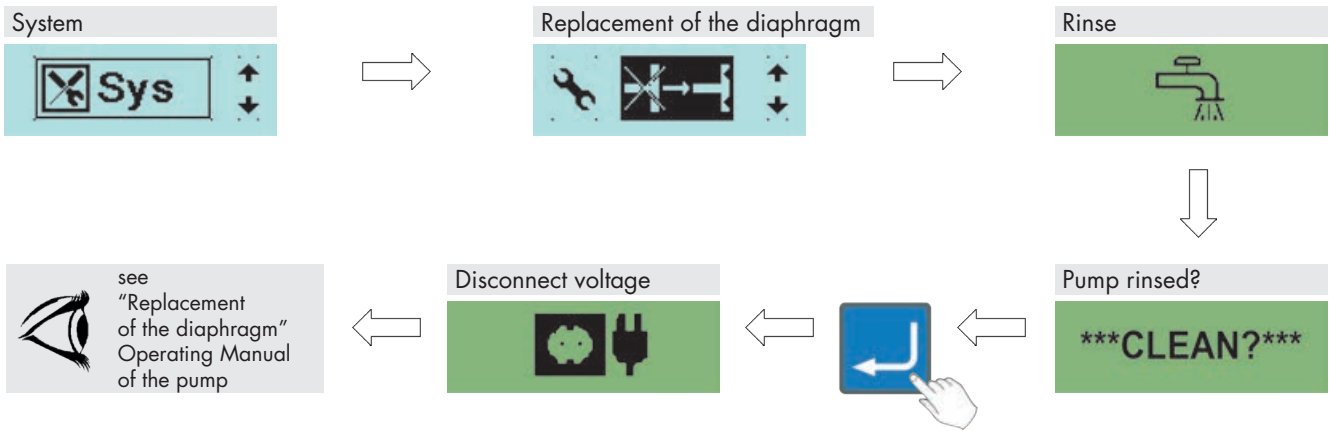

The counters for diaphragm operating hours and diaphragm service life are reset after successful diaphragm replacement.

Factory settings

Reset pump to factory settings (see parameters table for factory settings).

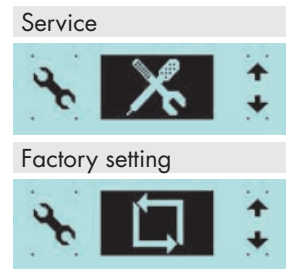

Messages

All messages that occur during operation are displayed here.
The displayed messages are in chronological order.



Tap on the text "delete list" to delete the list of messages from the memory.
However, this is only possible if the signal is no longer present. For example, if the fault has not been rectified, it is not possible to delete the error and it is written to the memory again.

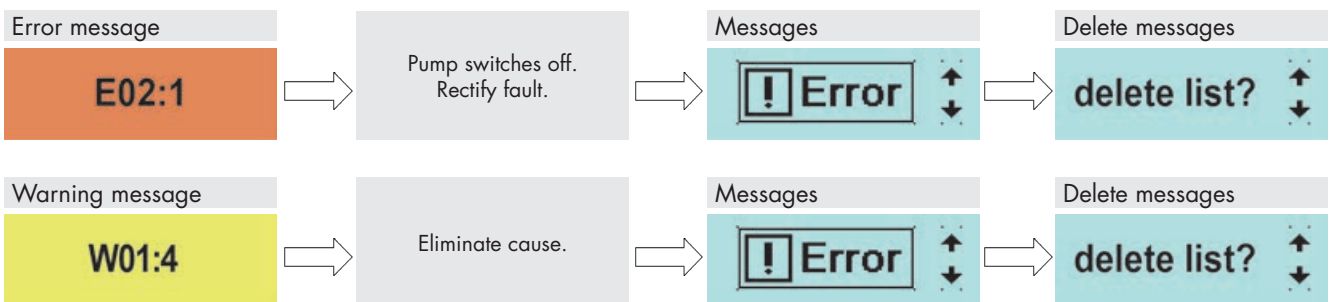

Settings (parameters)

The following table shows the factory settings for the stepper motor pump. Standard applications such as Manual Mode, Analogue Operation with 4-20 mA and Pulse Operation 1/1 and External Stop are preset.

The references to the respective chapters facilitate the adjustment of the settings. In addition, the parameter table provides the possibility to document the changes that have been made in the settings.

Overview of set parameters

	Factory settings	Page	Change	Change
Pulse operation				
Pulse memory	ON	16		
Pulse mode	1:1	16		
Pulse factor	1/1	16		
Analogue operation				
Signal	4-20 mA	17		
Input 1				
Function I1	Pulse	18		
Contact I1	Normally open contact	18		
Input 2				
Function I2	External stop	18		
Contact I2	Normally open contact	18		
Output 1				
Function O1	Ready to run	18		
Contact O1	Normally closed contact	18		
Output 2				
Function O2	Stroke signal	18		
Contact A2	Normally open contact	18		
Pre-alarm	NO contact	19		
Dry run	NO contact	19		
Password				
PW mode	OFF	21		
Password	0000	21		
Slow mode (stepper motor pump)				
Suction stroke	100%	19		
Diaphragm monitoring				
Input signal	Normally open contact	20		
Sensitivity	50%	20		
Calibration				
Active	NO	20		
Strokes	200	20		
Speed	80%	20		

TROUBLESHOOTING / FAULT CLEARANCE

sera products are sophisticated technical products which are only shipped after having been thoroughly tested and checked at our factory.

Nevertheless, if faults occur, they can be detected and rectified easily and quickly based on the error messages in the display and the instructions in the tables.

Error messages (E)

e.g. error memory: E02:1 ► second error in the memory ► diaphragm rupture

Error message	Possible cause	Corrective action
1 DRD		
2 Dry run		
4 Parametrisation error		
8 No stroke detection		
16 Analogue signal < 3.5mA		
32 Analogue signal > 20.5mA		
64 Stroke sensor error		
128 Error in power driver		
256 Electronics error		
512 Mains voltage too low		
1024 Mains voltage too high		
2048 Overtemperature, pump shutdown		
4096 Memory error		
8192 Short circuit / overload 24 V ext.		
16384 Electronics error		
32768 Electronics error		
	Electrical data of the pump do not match mains data.	Check order data. Check electrical installation.
	Broken wire in the analogue signal line.	Check the analogue signal line and repair if necessary.
	Actual analogue signal (e.g. 0-20 mA) does not match the analogue input specification (4-20 mA).	Adjustment of the actual analogue signal to the specification of the analogue input (4-20 mA).
	Short circuit or overload of pin 4 of the control socket. Output has been switched off for safety.	Check peripherals connected to the control socket and eliminate short circuit. Then restart pump.
	Overpressure, drive error, stroke sensor malfunction.	Check the back pressure, restart the pump with Start/Stop.
		Contact sera .
		Order diaphragm kit.
	Overtemperature due to overload or too high ambient temperature	Check ambient temperature.
	Medium level in storage tank too low or no medium.	Fill storage tank.
	Sensors of the dosing pump defective.	Contact sera .

Warning messages (W)

e.g. warning message: W01:4 ► first warning in the memory ► "Service now!" or diaphragm replacement

Warning message		Possible cause	Corrective action
256	Analogue input disturbed		
128	Leaving calibration range		
1	Pre-alarm level		
2	Step loss		
4	Diaphragm replacement		
8	Order service kit		
16	High temperature, pump not switched off		
32	Failed stroke sensor		
		Diaphragm has exceeded the maximum service life of one year or the maximum operating hours.	Contact sera and order diaphragm kit.
		Pre-alarm level of the storage tank has been undercut.	Fill storage tank with pumped medium.
		Hub sensor malfunction.	Contact sera in the case of persistent malfunction.
		Direct sunlight, ambient temperature too high, technical defect.	Reduce ambient temperature, protect against direct sunlight, take pump out of operation for a short time to reduce temperature.
		Overpressure, drive error	Check of the back pressure
		Service time reached	Order and use service kit.
		Stroke length < 20 % adjusted	Increase stroke length
		If pump calibrated: Stroke length deviates more than +/- 15 % of the calibrated value.	Correct stroke length
		Analogue/digital converter fault from analogue input	Get in contact with sera



WARNING

Safety instructions must be strictly observed and followed!
See supplementary instructions "SAFETY INSTRUCTIONS".
Man, machine and environment are endangered if the safety instructions are not observed.



Maintenance and cleaning

The control unit is maintenance-free. Clean with a moist cloth. Rub dry afterwards.

Decommissioning

- Disconnect device from the power supply.
- Detach electrical connections.
- Take device out of operation.

Disposal

Dispose of correctly and comply with the currently applicable local regulations after shutdown and dismantling.

- Disconnect the pump from the power supply.
- Connect the USB-M12 adapter (1) (90051890) to the USB stick FAT32 (2) and connect it to the pump.



- Press the START/STOP and UP buttons while switching the power supply of the pump back on.
- The pump is now in the update mode. Confirm the instructions with the ENTER button.
- The update is completed.
- The pump restarts automatically.
- Disconnect USB-M12 adapter from the pump.
- The pump is operational.

i NOTE

The parameter settings made on the pump are retained after the software update.

FOLLOW US



sera GmbH
sera-Str. 1
34376 Immenhausen
Germany
Tel. +49 5673 999 00
Fax +49 5673 999 01
info@sera-web.com

TM15-03 EN 10/2023. **sera** is a registered trademark of **sera GmbH**.
Subject to change without notice. **sera** shall not accept any liability for errors or omissions or for printing errors.