

## CONTROL Pro+ / iSTEP



### NOTE

Keep the operating manual for future use!

### ATTENTION

Subject to technical modifications!

### Quality notes

The **sera** quality management and quality assurance system is certified in accordance with DIN EN ISO 9001:2015.  
The **sera** product complies with the applicable safety requirements and accident prevention regulations.

## About this instructions

Special notes in these instructions are marked with text and danger symbols.

### NOTE

Notes or instructions that facilitate work and ensure a safe operation.

### ATTENTION

The non-observance of these safety instructions can result in malfunctions or material damages.

### WARNING

The non-observance of these safety instructions can lead to material damages and personal injuries.



Note on the additional instructions „SAFETY INSTRUCTIONS SI01“.

These technical manual is divided into the following main parts:

TRANSPORT & STORAGE	page 6
PRODUCT DESCRIPTION	page 7
TECHNICAL DATA	page 8
ELECTRICAL CONNECTION	page 9
OPERATION	page 12
FAULT ANALYSIS / CORRECTIVE ACTION	page 47
MAINTENANCE / SHUT-DOWN / DISPOSAL	page 49

# CONTENTS

---

<b>TRANSPORT / STORAGE</b> .....	<b>6</b>
General .....	6
Storage.....	6
<b>PRODUCT DESCRIPTION</b> .....	<b>7</b>
Pump connection.....	7
Controls .....	7
Accessoires .....	7
Suction lances with the prefabricated cable plug ► see sera product catalog.....	7
<b>TECHNICAL DATA</b> .....	<b>8</b>
ELECTRICAL DATA .....	8
AMBIENT CONDITIONS .....	8
TEMPERATURE DATA .....	8
<b>ELECTRICAL CONNECTIONS</b> .....	<b>9</b>
Electrical interfaces .....	9
<b>OPERATION</b> .....	<b>12</b>
Navigation.....	12
Start-up (initial commissioning).....	12
LED operation indicators .....	13
Menü.....	14
Operating modes .....	16
MANUAL operating mode .....	17
IMPULSE operating mode.....	17
ANALOGUE operating mode .....	20
BATCH operating mode .....	22
ANALOGUE batch mode .....	23
MANUAL batch mode .....	24
PULSE batch mode .....	25
RECIPE batch mode.....	26
TIMER operating mode .....	28
Inputs/outputs .....	29
Input 1 (digital) .....	30
Inputs 2 and 3 (digital/analogue) .....	31
Outputs 1 and 2 (digital) .....	32
Analogue output .....	33
Extras .....	34
Slow mode (stepper motor pump).....	34
Speed control (motor pump) .....	34
Speed limit .....	34
Dosing monitor .....	35
Adjustment of the flow monitor.....	36
Diaphragm monitor .....	37
Level .....	37
System.....	38
Language.....	38
Display .....	38
SD Card .....	38
Time .....	39
Password .....	39
Maintenance .....	40
Data transfer .....	41

---

Factory settings .....	41
Calibration of the delivery rate display .....	42
Info .....	44
Messages .....	44
Settings (parameters) .....	45
<b>FAULT ANALYSIS / FAULT CORRECTION .....</b>	<b>47</b>
<b>MAINTENANCE / DECOMMISSIONING / DISPOSAL .....</b>	<b>49</b>
Maintenance and cleaning .....	49
Decommissioning .....	49
Disposal .....	49
<b>SOFTWAREUPDATE .....</b>	<b>50</b>



### WARNING

Observe and follow the safety instructions by all means.  
See the additional instructions „SAFETY INSTRUCTIONS“.  
Man, machine and environment are endangered if the safety instructions are not observed.



### General

**sera** products are checked for perfect condition and function previous to shipment.  
Check for transport damage immediately after arrival of goods. If damage is found, this is to be reported immediately to the responsible carrier and the manufacturer.

### Storage

An undamaged packaging protects the unit during storage and should only be opened when the product is installed.  
Proper storage increases the service life of the product and includes prevention of negative influences such as heat, moisture, dust, chemicals etc.

The following storage specifications are to be observed:

- Storage place: cool, dry, dustfree and slightly ventilated
- Storage temperature and relative air humidity see Chapter „TECHNICAL DATA“.
- The maximum storage time for the standard packaging is 12 months.

If these values are exceeded, metal products should be sealed in foil and protected from condensation water with a suitable desiccant.

Do not store solvents, fuels, lubricants, chemicals, acids, disinfectants and similar in the storage room.

The manual control is used to set and operate the pump.

**i NOTE**

Softwareupdate see chapter „SOFTWAREUPDATE“ page 50.  
Data transfer between several pumps see chapter „Data transfer“ page 41“.

**Pump connection**

The control is not installed by **sera** for transport reasons. Connect the cable plug to the pump (5).

**Controls**

1	Graphical display
2	START/STOP
3	Click-Wheel
4	BACK



**Accessoires**

**Suction lances connection**

In order to connect the pump to a **sera** suction lance, an 8-pole cable connector with M12 thread is needed (accessory part number: 90042494 (1) or 90022885 (2)). This cable connector is connected to the level input of the control Pro+. See chapter "Level connection" for pin assignment.

Suction lances with the prefabricated cable plug ► see **sera** product catalog.



**INTERFACE MODULE**

The iNTERFACE MODULE provides level input, PROFIBUS connectivity (see TM05) and PROFINET connectivity (see TM07).



## TECHNICAL DATA

### ELECTRICAL DATA

Length of mains cable		3 m
Supply voltage / Control input internal / external	iSTEP	24 V DC / ... 30V DC
	C409.2	20 V DC / ... 30V DC
Min. contact signals time Minimum distance between pulses		55 ms
Certification		CE, TR

### SIGNAL INPUT

Voltage digital input		5 ... 30V DC
Max. load ► analog input		24 mA
Impedance at 0/4-20 mA ► analog input		39 $\Omega$
Max. resistance ► level input		4K $\Omega$
Max. resistance ► pulse circuit		100K $\Omega$
Sampling rate		1 ms

### SIGNAL OUTPUT

Impedance at 0/4-20 mA ► analog output		500 $\Omega$
Digital outputs internal / external supply	iSTEP	24V DC, 30mA /... 30V DC, 30mA
	C409.2	20V DC, 30mA /... 30V DC, 30mA

### AMBIENT CONDITIONS

Max. relative humidity		< 90%
------------------------	--	-------

### TEMPERATURE DATA

Max. operating temperature		40 °C
Min. operating temperature		0 °C
Max. storage temperature		40 °C
Min. storage temperature		0 °C



## WARNING

Observe and follow the safety instructions by all means.  
See the additional instructions „SAFETY INSTRUCTIONS“.  
Man, machine and environment are endangered if the safety instructions are not observed.



## Electrical interfaces

The control has 4 interfaces:



No.	Interface	Assignment	Function
1	External control	8-pole	Control inputs / control outputs
2	Flow monitoring and flow rate measurement	5-pole	Monitoring of the dosing flow. Set-up of a control circuit with a connected flow meter.
3	Level connection INTERFACE MODULE	8-pole	Pre-alarm and dry running protection. Connection for INTERFACE MODULE.
4	Manual control USB port	8-pole	Adjustment / operation of the pump. For software updates (see chapter „SOFTWAREUPDATE“ page 50). For the data transfer between pumps (see chapter „Data transfer“ page 41).

## i NOTE! \*

The following must be observed when the C409.2 Pro+ for C409.2 is replaced:

### Changed level connection

(connector 3 pin ► connecting socket 8 pin) - connecting cables with 3 pin cable socket must not be connected any more.)

Option 1: Exchange of the 3 pin cable socket with 8 pin cable connector (90022885) at the connecting cable.

Option 2: Use of a sera suction lance with connecting cable and suitable 8 pin cable connector (see price catalogue).

## External control (1)

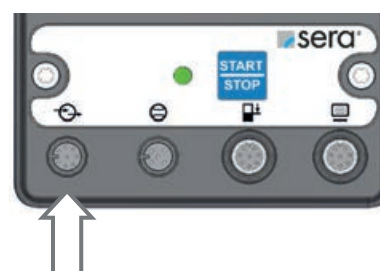
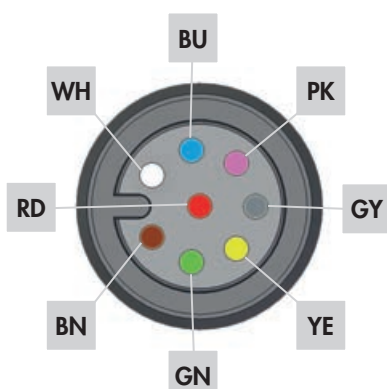

## ELECTRICAL CONNECTIONS

All inputs and outputs can be freely parametrised.



### ATTENTION

To prevent damage to the pump, parametrise the inputs and outputs before connecting the control cable.



### NOTE! \*

The following must be observed when the C409.2 Pro+ for C409.2 is replaced:

**Changed factory setting of the input configuration at the inputs 2 and 3.**

Configuration required for the operating modes ANALOGUE and EXTERNAL.

Inputs must be configured according to the following table for the application desired.

Pin assignments			Function (factory setting)	Pin	Other functions
WH	(white)	Input 1	Impulse	Pin 1	Recipe External stop Batch Start Analog 1/2 De-Aeration OFF
BN	(brown)	Input 2 *	External stop	Pin 2	Recipe Impulse Batch Start Analog 01 Batch Volume Batch Speed De-Aeration OFF
GN	(green)	Input 3 *	Analog 2	Pin 3	Recipe External stop Batch Start OFF Batch Volume Batch Speed De-Aeration Impulse
YE	(yellow)	24 V external	24 V external	Pin 4	–
GY	(grey)	Output 1	Collective fault	Pin 5	Stroke signal Pre-alarm level Dry-Running Diaphragm rupture Batch finished Internal error No flow Collective signal Pump active OFF Ready to Run
PK	(pink)	Output 2	Stroke signal	Pin 6	Pre-alarm level Dry-Running Diaphragm rupture Batch finished Internal error No flow Collective signal Pump active OFF Ready to Run Collective fault

Pin assignments	Function (factory setting)	Pin	Other functions
BU (blue) Analogue output	Analogue input	Pin 7	Remaining batch Stroke frequency
RD (red) Ground	Ground	Pin 8	–

### Flow monitoring and flow rate measurement (2)

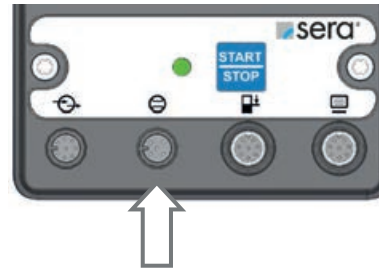
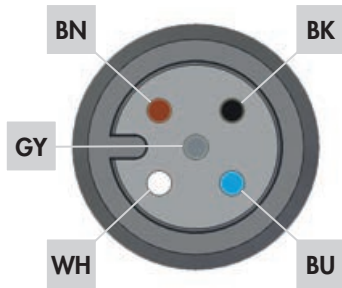

Wire colour	Pin	Function (factory setting)
BN (brown)	Pin 1	Analogue input (0/4-20 mA)
WH (white)	Pin 2	Inductive sensor (NAMUR)
BU (blue)	Pin 3	Digital input
BK (black)	Pin 4	15 V output (20 mA max.)
GY (grey)	Pin 5	Ground

### Level Connection (3)

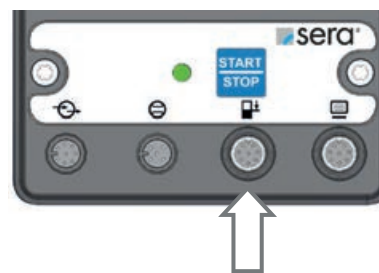
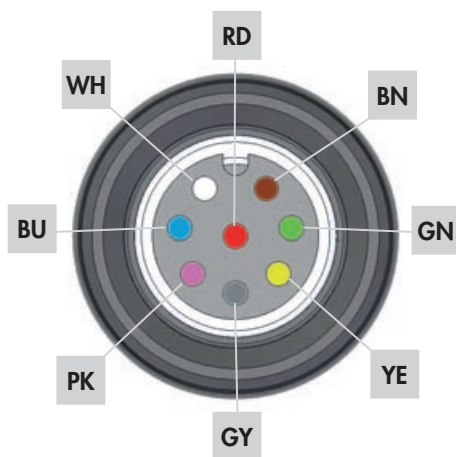

Wire colour	Pin	Function (factory setting)
PK (pink)	Pin 6	Pre-alarm level
BU (blue)	Pin 7	Dry-Running
RD (red)	Pin 8	Ground

The inputs can be switched using a floating contact signal.  
 Pre-alarm and dry running are set to normally open floating contacts at the factory.  
 The sockets of the connections are A-coded and the assignments of the functions are symbolically labelled.

## OPERATION



### WARNING

Observe and follow the safety instructions by all means.  
See the additional instructions „SAFETY INSTRUCTIONS“.  
Man, machine and environment are endangered if the safety instructions are not observed.



### ATTENTION

After the power supply is switched back on or restored after a power failure, the pump restarts with the set parameters in the selected operating mode.



### ATTENTION

Avoid briefly switching the supply voltage off and on again!  
A waiting time of at least two minutes must be observed between switching the pump off and on again!



### ATTENTION

Only operate the pump on an earthed mains supply!

## Navigation

DISPLAYSYMBOLE	
	Information
	Adjustment
	Warning message
	External stop
	Stroke movement
	SLOW-MODE <i>only by stepper motor pump</i>
	Home
	Flow measurement activated
	Flow rate recorded
	Back
	Selected



1

Tap the Click-Wheel



2

Click-Wheel rotation right



3

Click-Wheel rotation left

The **Information**, **Settings** and **Warnings** main menus have submenus and options.

Tapping the Back button always reaches the higher level menu.

A menu is selected by rotating the click wheel (2) (3) and tapping (1) opens the next menu level.

The position of the cursor always has a black background.

To change a numeric value, tap the click wheel (1) and select the value by rotating it.

Turning the click wheel to the right (clockwise) (2) increases the value and to the left (anticlockwise) (3) reduces the value.

Tapping (1) confirms the desired value and the cursor is free again.

## Start-up (initial commissioning)

Perform start up when commissioning the pump for the first time:

Select language:



- Set the date and time in the same way as the language setting.
- Start-up completed.

Default settings see parameters list.

## LED operation indicators

Operation indicators overview	LED (electronics case)			Display			
	LED (green)	LED (yellow)	LED (red)	blue	green	yellow	red
Ready	x			x			
Pump active	flashing				x		
Internal error			x				x
Mains voltage too low / too high			x				x
<b>Level monitoring:</b>							
Level pre-alarm – pump in operation		flashing			flashing	flashing	
Level pre-alarm – pump stopped		x				x	
Dry running			x				x
<b>Dosing monitoring (flow monitor or flow meter)</b>							
No flow – warning – pump in operation		flashing			flashing	flashing	
No flow – warning – pump stopped		x				x	
No flow – shutdown			x				x
Flow rate too low – Warning message		flashing			flashing	flashing	
Flow rate too low – Shutdown			x				x
<b>Optional diaphragm rupture monitoring</b>							
Diaphragm rupture			x				x
<b>Analogue operation</b>							
mA- signal < 3,5 mA			x				x
mA signal > 20,5 mA			x				x
<b>Service</b>							
Order service kit / Pump active		flashing			flashing	flashing	
Order service kit / Pump not active		x				x	
Warnings						x	
Error							x

Menü

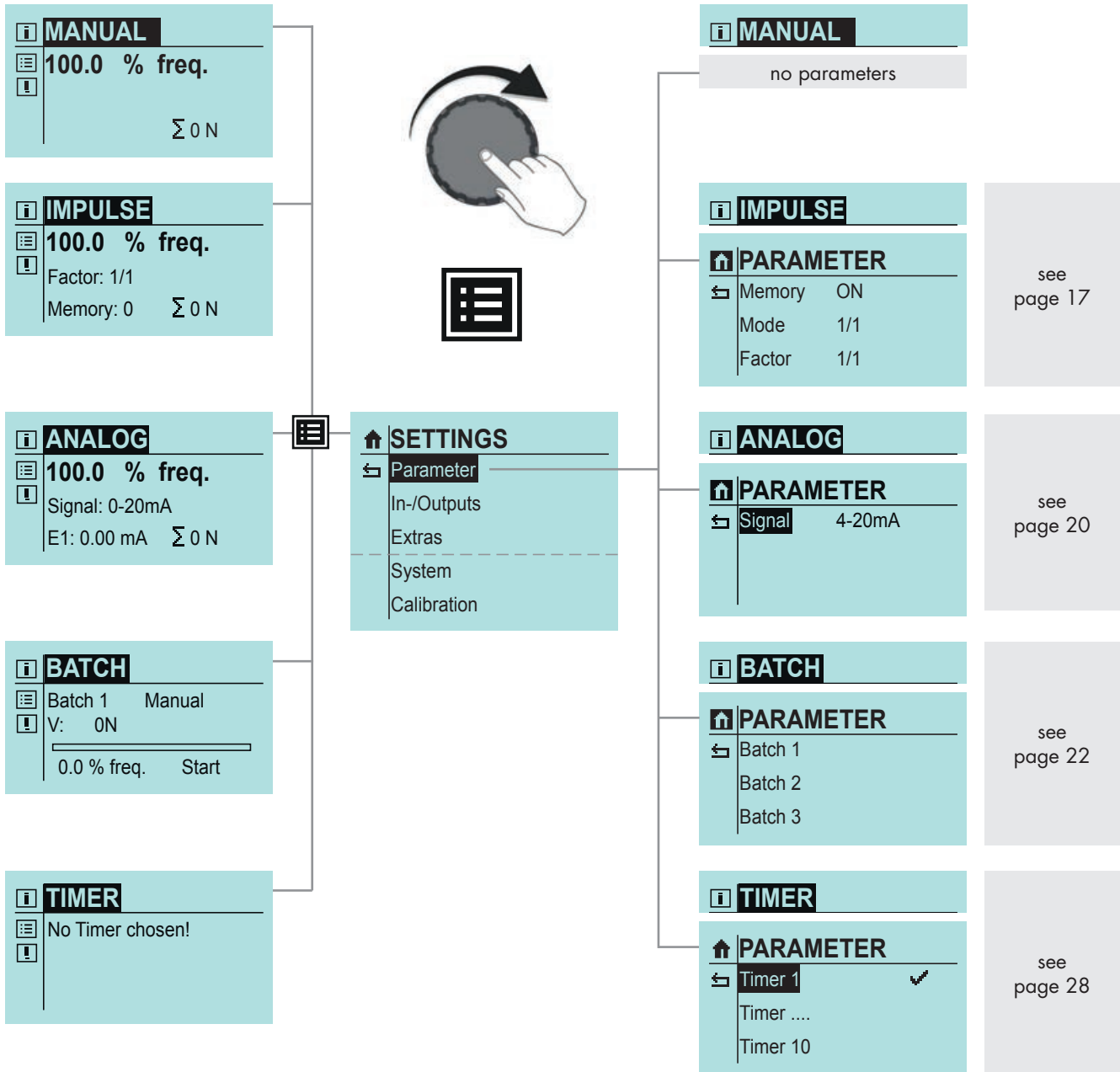

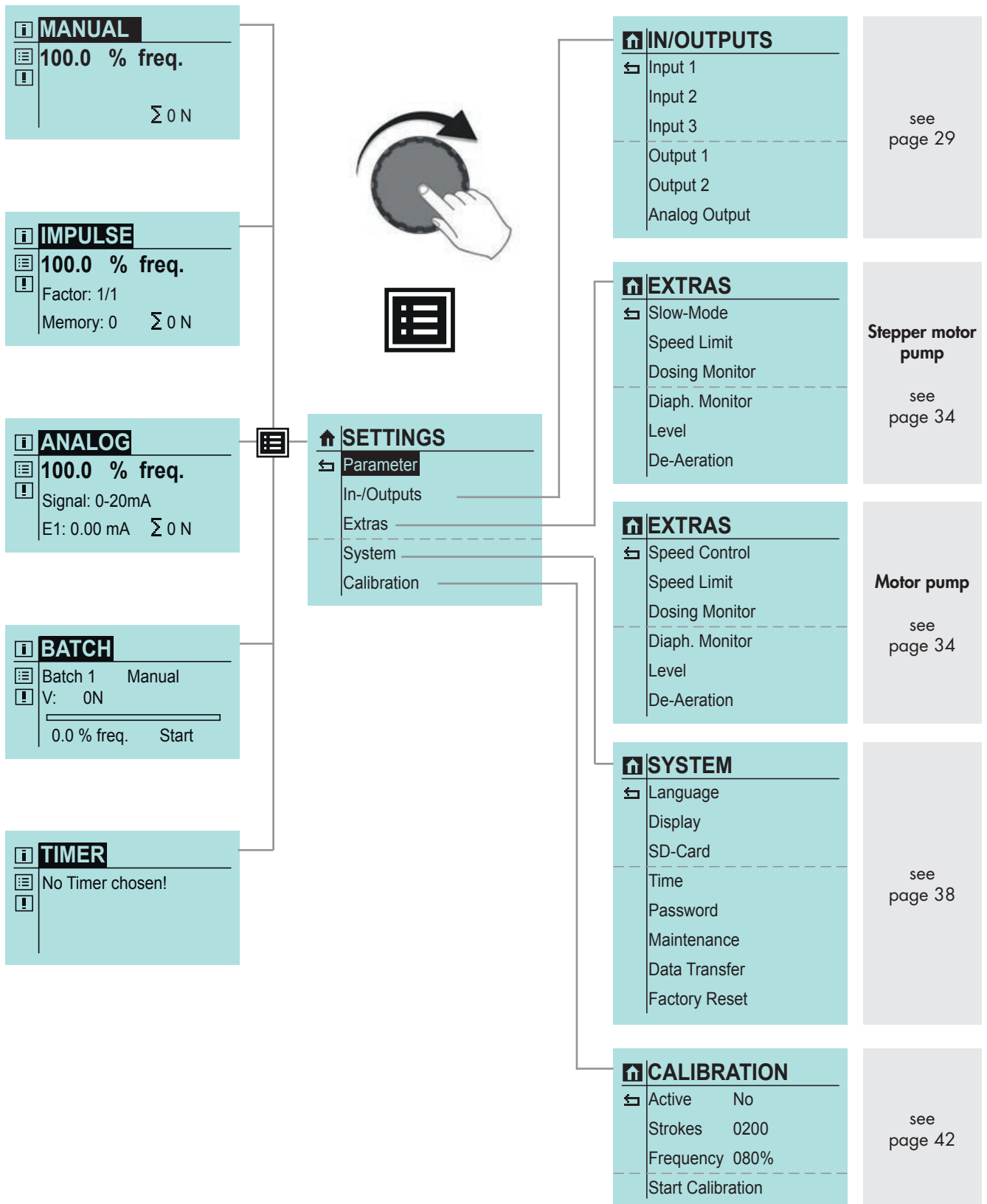

### Operating modes

You can select between five different operating modes:

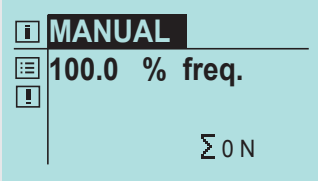
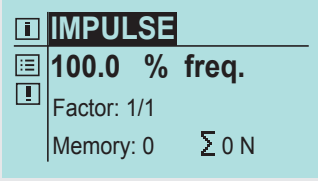
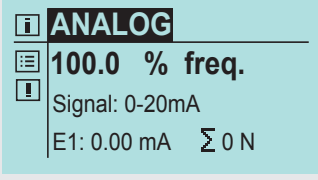
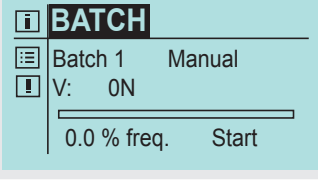
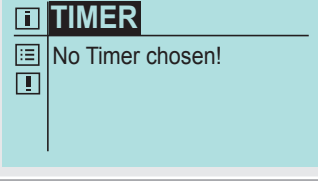
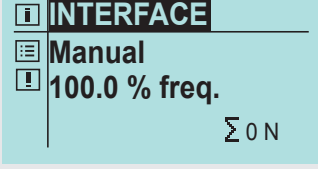
<p><b>MANUAL</b></p> <p>Local operation and control of the pump without external control. The flow rate can be set by specifying a stroke frequency. With a calibrated pump, the flow rate is set in l/h instead of via the stroke frequency.</p> <p>see page 17</p>	
<p><b>IMPULSE</b></p> <p>The pump can be operated using incoming pulses with transmission, reduction, 1/1 or with proportional operating (adjustment of the speed).</p> <p>see page 17</p>	
<p><b>ANALOG</b></p> <p>The stroke frequency of the pump is controlled via the received analogue signal.</p> <p>see page 20</p>	
<p><b>BATCH</b></p> <p>Batch dosing that is optionally manual using an external pulse signal from an incoming analogue signal. The batch quantity can be entered in strokes or in litres (only with a calibrated pump).</p> <p>see page 22</p>	
<p><b>TIMER</b></p> <p>It is possible to select between ten different timer settings.</p> <p>see page 28</p>	
<p><b>INTERFACE</b></p> <p>This operating mode is released by connection of a <b>sera</b> interface module. In the Interface operating mode the pump can be controlled, observed and parameterized via a PROFIBUS or PROFINET master.</p> <p>see TM05 (PROFIBUS) see TM07 (PROFINET)</p>	



## MANUAL operating mode

Standard adjustment of the delivery volume is made using the stroke frequency:

- 0-100% in 0.1% steps ► stepper motor pump
- 0-100% in 1% steps ► motor pump

After any calibration, the delivery volume is entered in the display as setpoint in l/h or ml/h instead of by stroke frequency adjustment (see „Calibration of the delivery rate display“, page 42). In the “Operating messages” view, the stroke frequency display is replaced accordingly with the flow rate display. The total delivery volume is also still indicated in litres.

### **i** NOTE

In the –PARAMETERS– menu, there are no adjustment possibilities for the MANUAL operating mode.

## IMPULSE operating mode

Connection of a pulse signal with external stop (Internal control voltage):

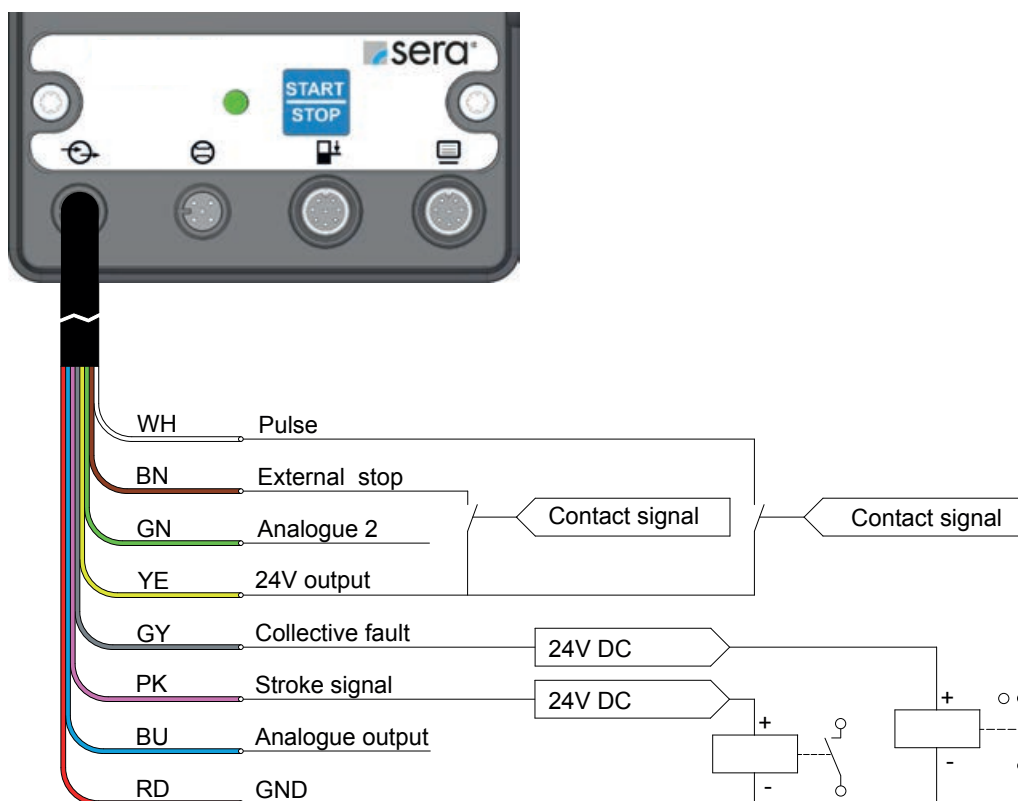

## OPERATION

Connection of a pulse signal with external stop (external control voltage / PLC):

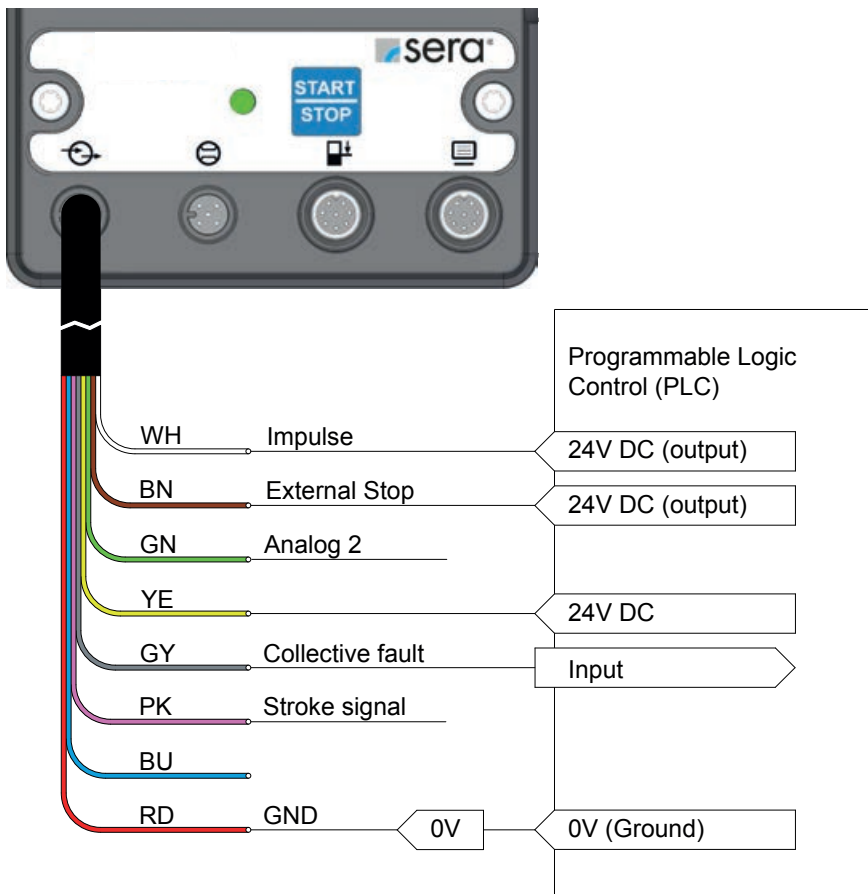

### **i** NOTE

In order to be able to use the IMPULSE operating mode, the IMPULSE function must be assigned to at least one input (see „Inputs/outputs“, page 29). Input 1 (see „Input 1 (digital)“, page 30) is set as pulse input and input 2 as external stop (see „Inputs 2 and 3 (digital/analogue)“ page 31) at the factory.

### **!** ATTENTION

The maximum load capacity of the control inputs and outputs is:

Inputs: 30V DC  
Outputs: 30V / 30mA

### **!** ATTENTION

The connection pin Output + / Signal + (wire colour: yellow) is not protected against short-circuit! In the event of short-circuit, there is the danger of damage to the control electronics! Therefore, it must be strictly ensured that the 24 V output connection is not directly connected to other connections!

### **!** ATTENTION

To prevent damage to the pump, parametrise the inputs and outputs before connecting the control cable.

There are 4 operating modes for the pulse operation:

PARAMETER	
Memory	ON → OFF
Mode	1/1 → Division; Multipl.; Proportional
Factor	1/1 → .../...

**Reduction**

In this mode, a reduction of the received pulses is performed. This means that the pump will only perform a stroke after an adjustable number of pulses (reduction factor) has been received.

**Transmission**

In this mode, a transmission of the received pulses is performed. This means that the pump will perform an adjustable number of strokes (transmission factor) after each received pulse.

**1/1**

In this mode, the pump performs exactly one stroke for each received pulse.

**Proportional**

The dosing starts with the first incoming pulse. If further pulses arrive during the dosing and a specified number of pulses in the pulse memory is exceeded, the delivery rate of the pump is increased until the accumulated pulses in the memory have been processed and the specified number of pulses is undercut again. If the pulses in the memory fall below the specified value again, the remaining pulses are processed with the original delivery rate again. The pulse memory must be set to "ON" for this operating mode.

PARAMETER	
Memory	ON
Mode	Proportional
Limit	1
Stroke Freq.	50,0% freq.

**Selecting the PULSE FACTOR**

Depending on the selected pulse mode, the pulse factor corresponds either to the reduction factor or the transmission factor. The **reduction** factor can be selected between 1 and 999. For example, if a reduction factor of 50 is selected, then the pump will only perform a stroke with every 50th received pulse. The **transmission** factor can be selected between 1 and 999. For example, if a transmission factor of 50 is selected, then the pump will perform 50 strokes with every received pulse.

**Switching the PULSE MEMORY ON/OFF**

The pump is equipped with a pulse memory, which can optionally be switched ON and OFF. A maximum of 999 strokes can be saved. If the number of received pulses exceeds the number that can be handled by the pump, then the pulses will be buffered and the strokes will be performed later.

### ANALOGUE operating mode

Connection of two analogue inputs with switching:

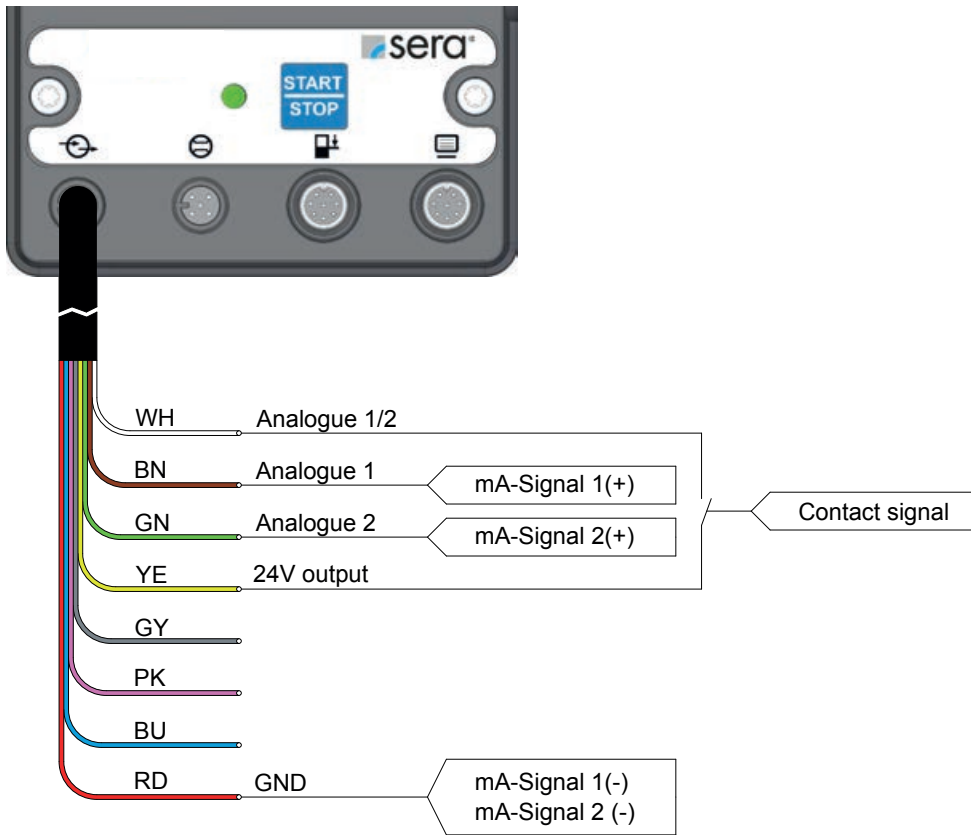

#### **i** NOTE

In order to be able to use the ANALOGUE operating mode, the ANALOGUE 1 or ANALOGUE 2 function must be assigned to at least one input (see „Inputs 2 and 3 (digital/analogue)“, page 31). Input 3 is set as analogue input (ANALOGUE 2) at the factory.

#### **!** ATTENTION

To prevent damage to the pump, parametrise the inputs and outputs before connecting the control cable.

#### Selecting ANALOGUE SIGNAL

You can select between three different analogue signals:

- 0-20 mA
- 4-20 mA
- Adjustment

<b>ANALOG</b>
<b>100.0 % freq.</b>
Signal: 0-20mA
E1: 0.00 mA $\Sigma$ 0 N

<b>PARAMETER</b>	
Signal	4-20mA → 0-20mA; Adjustment

**i NOTE**

**Hysteresis**

The controller starts dosing at a stroke frequency of 0.5% and stops the dosing process at 0.0% stroke frequency.

**0-20 mA**

A signal with a control current of 0 mA corresponds to 0% stroke frequency; a signal with 20 mA corresponds to 100% stroke frequency. In this range, the stroke frequency behaves linearly to the control current (see following figure). If the input signal is > 20.5 mA, the pump stops and the "Analogue signal > 20 mA" signal is output.

**4-20 mA**

A signal with a control current of 4 mA corresponds to 0% stroke frequency; a signal with 20 mA corresponds to 100% stroke frequency. In this range, the stroke frequency behaves linearly to the control current (see following figure).

If the input signal is < 3.5 mA, the pump outputs an "Analogue signal < 4 mA" signal. Thus, a wire break (control) current = 0 mA) can be detected. If the input signal is > 20.5 mA, the pump stops and the "Analogue signal > 20 mA" signal is output.

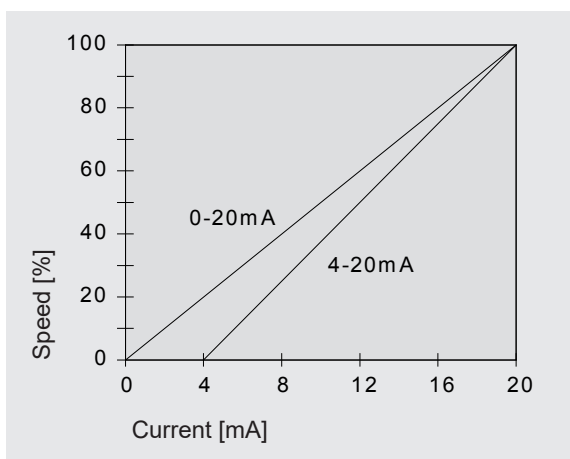

**Adjustment**

The analogue control signal can be adjusted specifically for the application. For example, this is necessary if a connected regulator provides a limited output signal.

Two points are given that reflect a linearly relation between control current and stroke frequency of the pump. In addition, these two points restrict the stroke frequency range of the pump as shown in the example in the following figure.

**Example: Adjustment of the analogue signal**

- Point 1: 15% stroke frequency at 5 mA
- Point 2: 80% stroke frequency at 15 mA

If the control current is <5 mA, the stroke frequency of the pump is 0%.  
 If the control current is >15 mA, the stroke frequency of the pump is 80%.

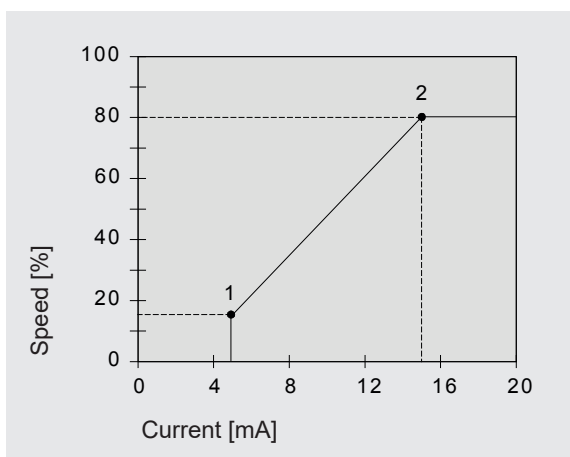

PARAMETER	
Signal	Adjustment

PARAMETER	
Signal	Adjustment
Analog I1	05,0 mA
Frequency f1	000 %
Analog I2	15,0 mA
Frequency f2	080 %

### BATCH operating mode

Possible connections assignment for batch mode:

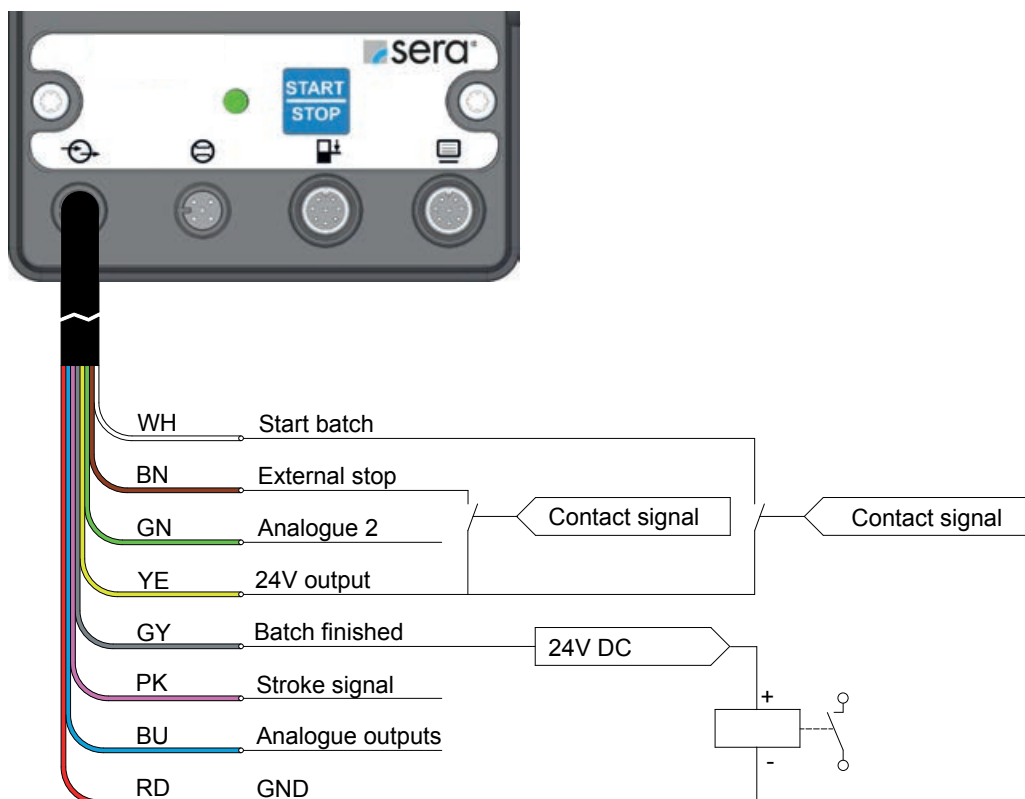

#### ⚠ ATTENTION

The maximum load capacity of the control inputs and outputs is:

Inputs: 30V DC  
Outputs: 30V / 30mA

#### ⚠ ATTENTION

The connection pin Output + / Signal + (wire colour: yellow) is not protected against short-circuit! In the event of short-circuit, there is the danger of damage to the control electronics!  
Therefore, it must be strictly ensured that the 24 V output connection is not directly connected to other connections!

#### ⚠ ATTENTION

To prevent damage to the pump, parametrise the inputs and outputs before connecting the control cable.

## ANALOGUE batch mode

Both available analogue inputs and the remaining digital input of the pump are used for operation in the Analogue batch mode. The required batch volume is specified using one of the analogue inputs. The required maximum batch volume is specified during the parametrisation of the pump for this. The significance of this batch volume corresponds to the input signal of 20 mA. All smaller input signals are linearly offset up to 4 mA with the specified maximum volume. The batch quantity for all input signals under 4 mA is 0 litre.

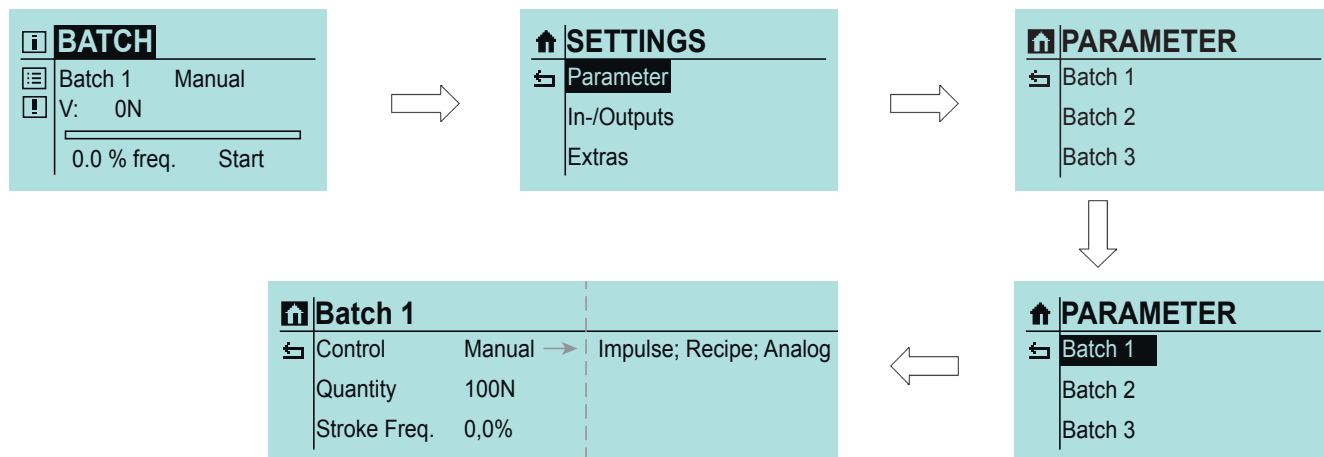

### Example:

Specified maximum batch volume: 10 litres

Input signal:	20 mA	batch volume:	10.0 litres
Input signal:	12 mA	batch volume:	5.0 litres
Input signal:	4 mA	batch volume:	0.0 litre
Input signal:	16 mA	batch volume:	7.5 litres

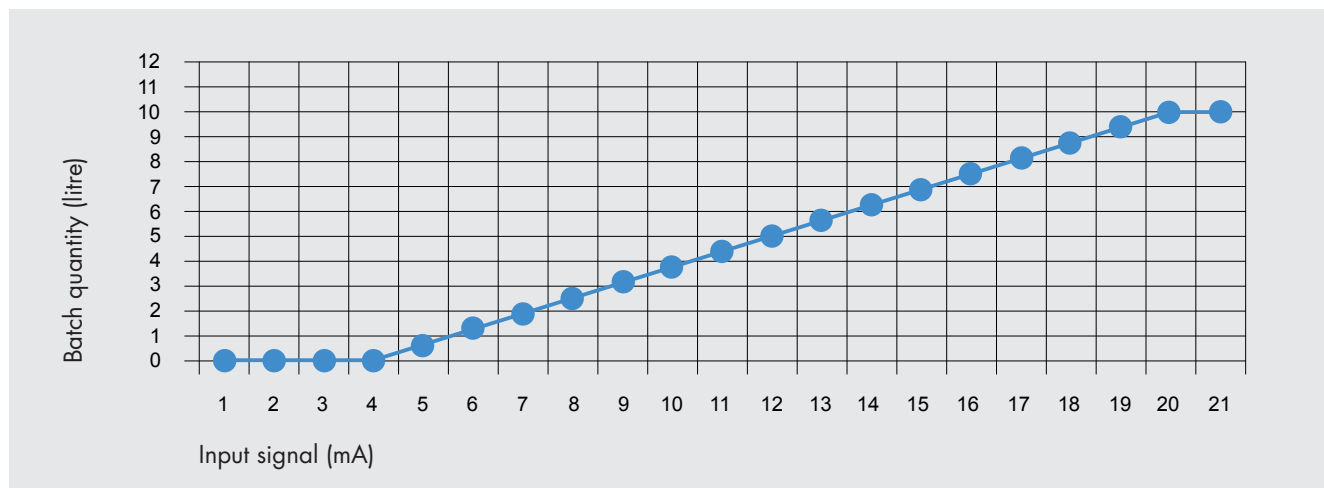

The stroke speed is set in the same way as for the batch quantity. First select the maximum value that corresponds to the 20 mA signal. The delivery rate can now be set using an appropriate input signal between 4 mA and 20 mA.

In contrast to the batch quantity, the delivery rate can also be changed during the delivery of a batch. The batch must not be active to change the batch quantity via the input signal. The batch quantity that has been specified using the input signal is retained at the beginning of the batch delivery. Then the input signal no longer has any influence on the batch quantity.

A signal at the digital input is required to start the conveying process. This signal must be maintained during the conveying process. The current batch is cancelled if the signal is interrupted before the end of the batch conveyance. A new batch starts when the signal is applied again.

The batch can be paused by adjusting the delivery rate.

### MANUAL batch mode

For the manual batch, the batch is started, paused if necessary, and stopped directly at the pump. One of the three batches must be adjusted in accordance with the requirement.

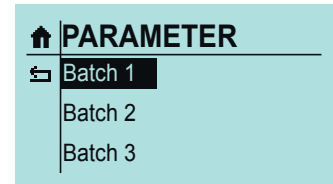
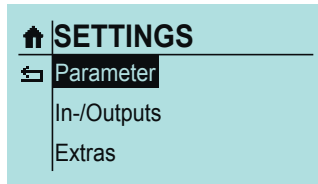
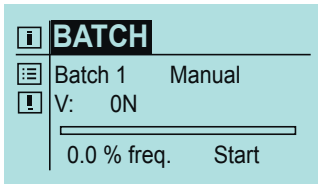

(Example: manual batch, 200 strokes (quantity N) at 50% stroke frequency)

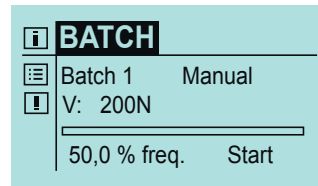
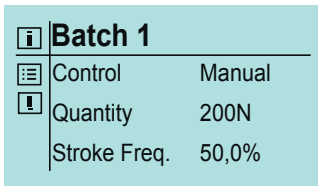

#### Start of the manual batch:

Navigate to "Start" in the display.

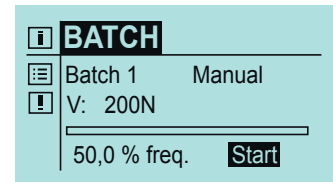

Press START/STOP button on the manual control (or on the pump case)

(display colour changes to green).

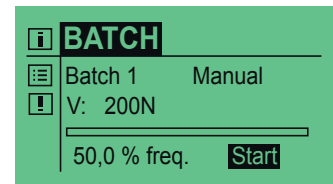

The batch can now be started using the Click wheel.

V = number of strokes of the batch  
 R = remaining strokes of the batch  
 The bar shows the progress of the batch.  
 The batch dosing can be paused by tapping the Click wheel.

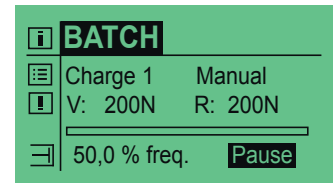

Tapping again restarts and continues the batch dosing.

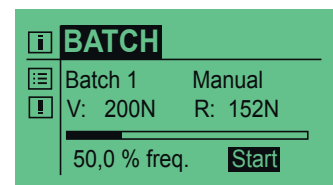

#### i NOTE

Tapping the Back button cancels the batch.



#### i NOTE

Signals for "remaining batch" and "batch ended" can be evaluated using appropriately configured outputs (see „Outputs 1 and 2 (digital)“, page 32).



## PULSE batch mode

Input must have the Start Charge function. The activation of the charge must be set to "pulse" in Parameters. The selected charge starts for an incoming pulse.

<b>BATCH</b>	
Batch 1	Manual
V: 0N	
0.0 % freq.	Start

<b>SETTINGS</b>	
Parameter	
In-/Outputs	
Extras	

<b>PARAMETER</b>	
Batch 1	
Batch 2	
Batch 3	

(Example: pulse batch, 200 strokes (quantity N) at 50% stroke frequency)

<b>Batch 1</b>	
Control	Impulse
Quantity	200N
Stroke Freq.	50,0%



<b>BATCH</b>	
Batch 1	Impulse
V: 200N	
50,0 % freq.	

**i NOTE**  
The configuration of an input with the „Start batch“ control is required for the pulse batch mode (see „Inputs/outputs“, page 29).

Press START/STOP button on the manual control (or on the pump case).

(display colour changes to green).



<b>BATCH</b>	
Batch 1	Impulse
V: 200N	
50,0 % freq.	

The batch now starts as soon as a pulse is received via the appropriate input.

**i NOTE**  
Signals for "remaining batch" and "batch ended" can be evaluated using appropriately configured outputs (see „Outputs 1 and 2 (digital)“, page 32).

### Cancellation of the batch

The batch can be cancelled using the START/STOP buttons on the pump or by an external signal ("External Stop").

**i NOTE**  
Another input must be configured accordingly for „External stop“ (see „Inputs/outputs“, page 29).

**RECIPE batch mode**

Up to three batches can be programmed independently from each other in the RECIPE batch mode. The control of the respective batch must be set to "Recipe".

<p><b>BATCH</b></p> <p>Batch 1 Manual</p> <p>V: 0N</p> <p>0.0 % freq. Start</p>	<p><b>SETTINGS</b></p> <p>Parameter</p> <p>In-/Outputs</p> <p>Extras</p>	<p><b>PARAMETER</b></p> <p>Batch 1</p> <p>Batch 2</p> <p>Batch 3</p>
<p><b>Batch 1</b></p> <p>Control Recipe</p> <p>Quantity 250N</p> <p>Stroke Freq. 80,0%</p>	<p><b>BATCH</b></p> <p>Batch 1 Recipe</p> <p>V: 250N</p> <p>80,0 % freq.</p>	

(Example shows three different batch settings).

<p><b>BATCH</b></p> <p>Batch 1 Recipe</p> <p>V: 250N</p> <p>80,0 % freq.</p>	<p><b>BATCH</b></p> <p>Batch 2 Recipe</p> <p>V: 1500N</p> <p>50,0 % freq.</p>	<p><b>BATCH</b></p> <p>Batch 3 Recipe</p> <p>V: 50N</p> <p>77,5 % freq.</p>
--	---	---

**i NOTE**

The functions of the inputs must be set to „Recipe“ in each case (see „Inputs/outputs“, page 29).

Press START/STOP button on the manual control (or on the pump case).

(display colour changes to green).



**BATCH**

Batch 1 Recipe

V: 250N

80,0 % freq.

The respective batch now starts as soon as a signal is received via the appropriate input.

**i NOTE**

The input signal must be present continuously - the current batch is cancelled as soon as the signal is no longer present.

Input 1 starts batch 1  
 Input 2 starts batch 2  
 Input 3 starts batch 3

**i NOTE**

Incoming signals during the batch dosing are not buffered.

The repetition of any batch (or the start of another batch cannot be performed until after completion of the running batch).

**Cancellation of the batch during the batch dosing**

can be performed using the START/STOP buttons on the pump  
is performed by interruption of the input signal

**i NOTE**

Signals for „remaining batch“ and „batch ended“ can be evaluated using appropriately configured outputs (see „Outputs 1 and 2 (digital)“, page 32).

## OPERATION

### TIMER operating mode

Select TIMER operating mode.

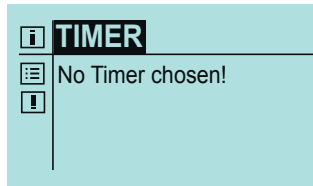

There are **10 independent timers** available.

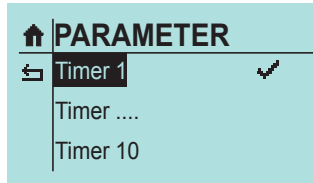

The timers enable batch dosing where a batch begins at a specified time or any time-controlled ACTIVATION and DEACTIVATION of the pump.

A stroke frequency can be assigned to each timer.

An interval of consecutive days (Mon-Fri, Mon-Sun, Sat-Sun) or individual days of the week can be assigned to the timers.

Timer 1	
Mode	OFF → Manual; Batch
Interval	Daily → Weekday
Period	Mo-Su Mo-Fr; Sa-Su
Start	00:00
End	00:00 → at Mode "OFF" and "Manual"
Batch:	V: ON → at Mode "Batch"
Stroke Freq.	0,0 % freq.

#### Example:

Manual dosing (at 50% stroke frequency) should be performed on a weekday (Tuesday) from 10:00 to 10:30 in each case.

#### Process

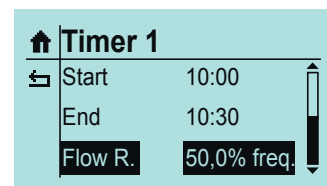
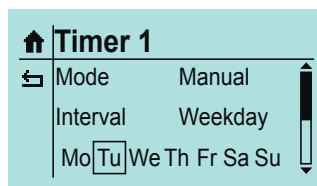
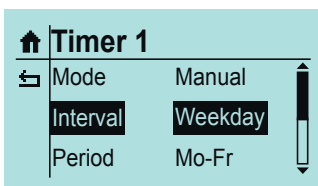
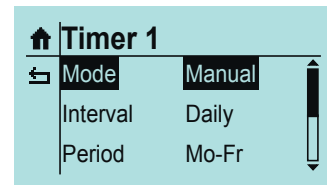
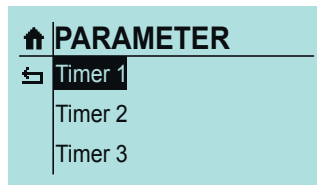
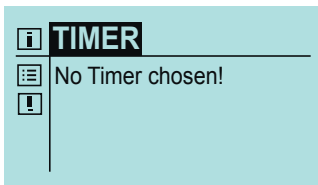

Press START/STOP button on the manual control (or on the pump case).

(display colour changes to green).

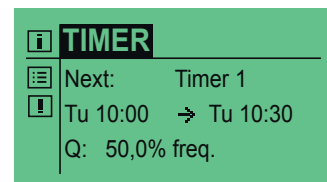

### i NOTE

Any possible overlapping of specified time periods is prevented (an appropriate message is shown on the display).

## Inputs/outputs

The pump is equipped with three inputs and three outputs that can be variably configured via a menu in accordance with the respective operating conditions.

It is possible to assign the same functions to all three inputs.

### **i** NOTE

If several inputs are configured identically, the input signals will be evaluated via OR operation. This means that the function will be performed as soon as any of the inputs fulfils the condition.

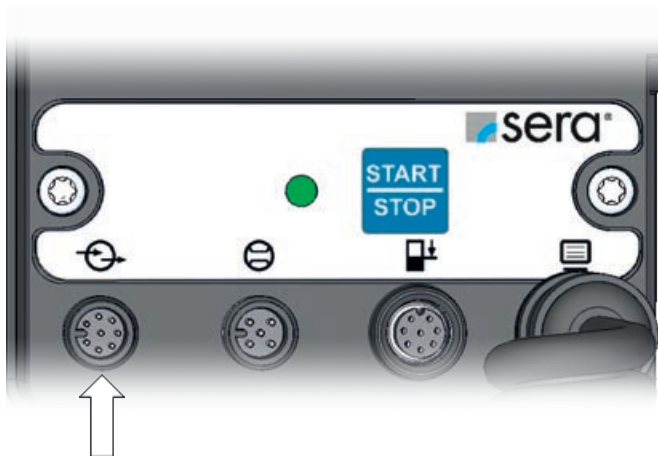

### Inputs and outputs

(see the operation instruction of the pump)

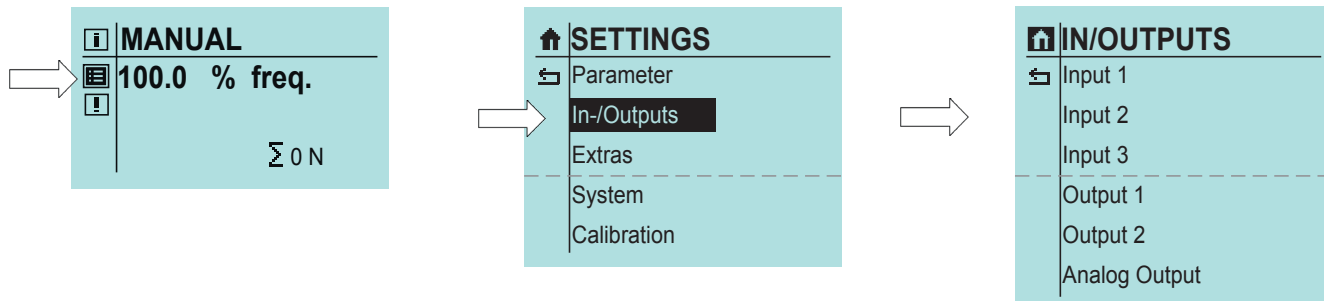

### Input 1 (digital)

One of six different functions can be assigned to input 1. Optionally, a switch off is also possible.

**Function**

**OFF**

No function is assigned to the input.

**External stop**

Function for stopping the pump externally. This function is valid across operating modes.

**Input 1**

Function: OFF  
Extern Stop  
De-Aeration  
Impulse  
Analog 1/2  
Recipe  
Batch Start  
Extern Pause

Contact: NO  
NC

**i NOTE**

The External stop symbol is shown in the display if the pump is stopped using External stop. A running batch is aborted by **Extern Stop**.

**De-Aeration**

Configuration of the input for activating the de-aeration.

**Impulse**

Configuration of the input as pulse input

**Analogue 1/2**

This function is used for switching between the two analogue inputs. Analogue 1 and Analogue 2 (inputs 2 and 3) via Input 01. The analogue input is selected according to the table.

Switching analogue input		
Configuration contact E1	Applied signal	Selected analogue input
NORMALLY CLOSED CONTACT	High	Analogue 1 (Input 2)
NORMALLY CLOSED CONTACT	Low	Analogue 2 (Input 3)
NORMALLY OPEN CONTACT	High	Analogue 2 (Input 3)
NORMALLY OPEN CONTACT	Low	Analogue 1 (Input 2)

**Recipe**

Configuration of the input for the batch recipe selection operating mode.

**Batch Start**

Function for starting the batch externally.

**External Pause**

Function to pause the pump by an external signal.

**i NOTE**

If the pump is stopped via External Pause, the pause symbol appears in the display.  
A running batch is continued after canceling the **extern pause**.

**MANUAL**

100.0 % freq.

∑ 0 N

**Contact**

Normally open contact / Normally closed contact - Configuration of the contact type (NO or NC).

## Inputs 2 and 3 (digital/analogue)

Basically, input 2 and input 3 have the same functions as input 1. Furthermore, they can be used as analogue inputs (Analogue 1/Analogue 2/Batch quantity/Batch speed). However, the function "Analogue 1/2" which is used to switch over between the analogue inputs is not available. In addition, it is possible to configure the contact signals of the inputs as NO or NC (not relevant for analogue).

### Function

#### OFF

No function is assigned to the input.

#### External stop

Function for stopping the pump externally.

**i NOTE**

The External stop symbol is shown in the display if the pump is stopped using External stop (see arrow). A running batch is aborted by **Extern Stop**.

#### De-Aeration

Configuration of the input for activating the de-aeration.

#### Impulse

Configuration of the input as pulse input

#### Analogue 1 (for Input 2) and Analogue 2 (for Input 3)

The respective input is configured as an analogue input.

**i NOTE**

If the inputs 2 and 3 are configured as analogue inputs, the changeover between these two analogue inputs is made via Input 1 (function: Analogue 1/2).

#### Recipe

Configuration of the input for the Batch recipe selection operating mode

#### Batch Start

Function for starting the batch externally

#### Batch Volume

Function for specification of the batch volume (quantity)  
(20 mA corresponds to the value set under Batch parameters)

#### Batch Speed

Function for specification of the batch speed.  
(20 mA corresponds to the value set under Batch parameters)

#### Extern Pause

Funktion zum Pausieren der Pumpe durch ein externes Signal.

**i HINWEIS**

If the pump is stopped via External Pause, the pause symbol appears in the display. A running batch is continued after canceling the **extern pause**.

### Contact

**Normally open contact / Normally closed contact** - Configuration of the contact type (NO or NC).

**⚠ ATTENTION**

To prevent damage to the pump, parametrise the inputs and outputs before connecting the control cable.

**Input 2**

Function: OFF  
Extern Stop  
De-Aeration  
Impulse  
Analog 1  
Recipe  
Batch Start  
Batch Volume  
Batch Speed  
Extern Pause

Contact: NO  
NC

**Input 3**

Function: OFF  
Extern Stop  
De-Aeration  
Impulse  
Analog 2  
Recipe  
Batch Start  
Batch Volume  
Batch Speed  
Extern Pause

Contact: NO  
NC

**MANUAL**

100.0 % freq.

Σ 0 N

**MANUAL**

100.0 % freq.

Σ 0 N

## Outputs 1 and 2 (digital)

Each of the outputs 1 and 2 can be assigned one of twelve different functions (the functions are identical for both outputs).  
 Optionally, a switch off is also possible.  
 It is also possible to configure the contact signals of the outputs as NO or NC.

### Function

#### OFF

No function is assigned to the output.

#### Ready to Run

Signal for operational readiness of the motor pump.

#### Pump Active

Pump is in operation.

#### Stroke Signal

Signal for execution of a stroke.

#### Pre-Alarm Lev. (level pre-alarm)

Signal of the pre-alarm for two-stage level monitoring.

#### Dry-Running

Signal of the dry running for level monitoring.

#### Diaphr. Rupt (Diaphragm rupture)

Signal of a diaphragm rupture for diaphragm rupture monitoring.

#### No Flow

With activated flow control, signal indicating that the permitted number of fault strokes for fault monitoring has been exceeded.

#### Coll. signal (Collective signal)

Signal indicating that any of the following faults has occurred:

- All faults of the collective fault
- Pre-alarm level
- No flow (for MESSAGE function)

#### Coll. fault (Collective fault)

Signal indicating that any of the following faults has occurred:

- Diaphragm rupture
- Dry run
- Internal error
- No flow

#### Int. Error (Internal error)

Signal indicating that any of the following faults has occurred:

- Fault drive
  - Fault stroke sensor
  - No stroke detection
  - Setpoint cannot be achieved
- (see the operation instructions, chapter "Troubleshooting and fault clearance") for fault descriptions / causes

#### Batch Finished

Signal of the end of batch for batch operating mode.

#### De-Aeration

Signal is present when de-aeration is active.

### Contact

**Normally open contact / Normally closed contact** - Configuration of the contact type (NO or NC).

### Output 1

### Output 2

Function:	OFF Ready to Run Pump Active Stroke Signal Pre-Alarm Lev. Dry-Running Diaphr. Rupt. No Flow Coll. Signal Coll. Fault Internal Error Batch Finished De-Aeration
Contact:	NO NC



## Analogue output

### Function

#### A. Input (analogue input)

The current present at the analogue input is output again 1 to 1.

#### Stroke Freq. (stroke frequency)

Output of a current depending on the stroke frequency.

Can be output as signal 0-20 mA, 4-20 mA and standardised.

#### Rem. Batch (remaining batch)

Output of a current depending on the residual charge. The larger the percentage of the residual charge, the larger is the output current.

#### Example:

Batch quantity: 10 l, remaining batch 7.5 l => 75% still to convey

Mode: 0-20 mA > output current 75% of 20 mA => 15 mA

↑ Analog output	
↔ Function	A. Input

↑ Analog output	
↔ Function	Stroke Freq.
Signal	0-20mA → 4-20mA; Adjustment

↑ Analog output	
↔ Function	Rem. Batch
Signal	0-20mA → 4-20mA; Adjustment

**Extras**

Select Settings icon (arrow).  
 Select "Extras".

The extras settings are independent from the operating mode.

- Slow mode
- Speed limit
- Dosing monitor
- Diaphragm monitor
- Level

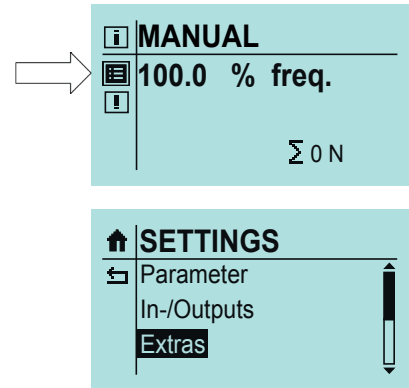

**Slow mode (stepper motor pump)**

In Slow mode, the pump is operated at reduced speed in the suction stroke. This is useful, for example, if media with high viscosity are to be conveyed.

The speed of the suction stroke can be set to 75, 50 or 25% of the normal suction stroke speed.

Due to the reduced suction stroke speed, the maximum configurable delivery quantity reduces (see "Technical data" in the operation instructions of the pump).

The Slow mode symbol (arrow) is shown on the Home display.

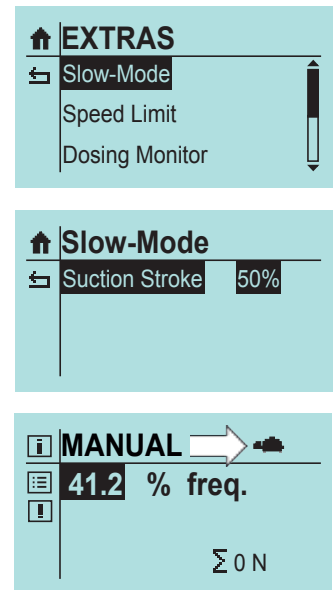

**Speed control (motor pump)**

Two different functions can be chosen:

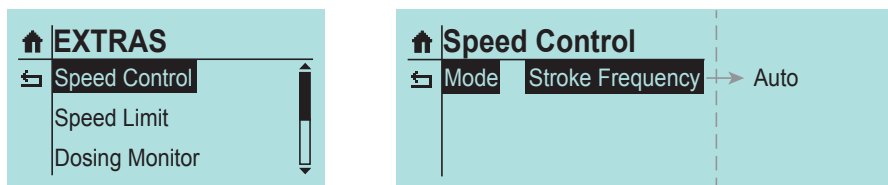

**Auto**  
 The motor speed is adjusted corresponding to the stroke frequency. If the stroke frequency falls below 30% operation changes to Stop&Go.

**Stroke frequency**  
 Stop&Go operation covering the whole stroke frequency range, that means every stroke is performed with full motor speed.

**Speed limit**

The maximum configurable speed of the pump in operation can be limited (10-100% - stepper motor pump / 30-100% - motor pump).

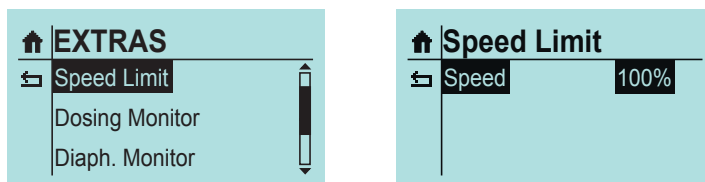

## Dosing monitor

The connection of a **sera** flow monitor to the dosing pump enables monitoring of the flow rate of the dosing pump.

**i NOTE** (Stepper motor pump)

The functionality of the flow monitor in connection with the SlowMode 25% function is not possible until from the iSTEP S40.

The connection of a **sera** flow meter to the dosing pump provides a more detailed flow rate indication with regulation of the flow rate.

The following items can be adjusted:

### SENSOR

Selection of a connected **sera** flow monitor (type 8x9x.1) or **sera** flow meter (type 801x.1).

### FUNCTION

Selection of the dosing monitoring function. It can be selected whether the dosing monitoring should trigger a warning message (WARNING) or a switch-off of the pump (PUMP STOP).

### FAULT STROKES

Number of fault strokes at which a connected flow monitor triggers the dosing monitor.

The factory setting is 10 fault strokes. This means that the dosing monitoring will react if the flow monitor does not give a stroke confirmation to the pump for the duration of ten consecutive strokes.

### ALARM LIMIT

Alarm limit at which a connected flow meter triggers the dosing monitor. The entered value corresponds to the percentage part of the setpoint flow rate. The factory setting is 80%. This means that the dosing monitor will react if a connected flow meter measures a flow rate which is lower than 80% of the setpoint flow rate.

After the adjustment, the symbol for the flow rate measurement (arrow) is shown on the Home display.

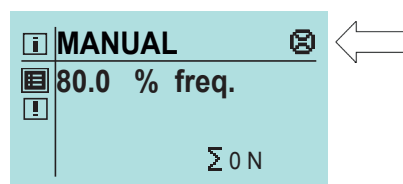
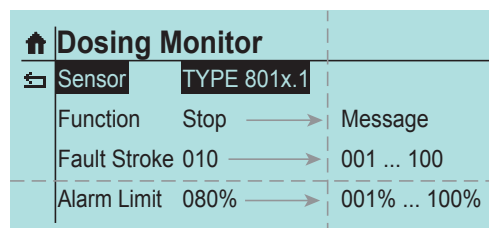
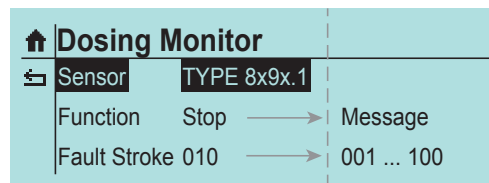
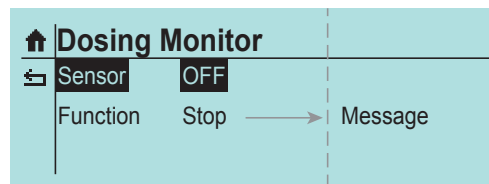
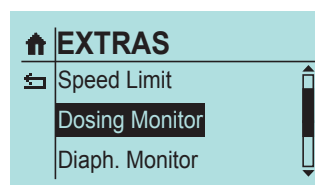

### Adjustment of the flow monitor

Set „Manual“ operating mode.  
Let medium be suctioned by the pump so that the flow monitor is filled.  
Activate the flow sensor 8x9x.1 in the flow monitoring (Settings Extras Flow Monitoring).

The following symbol is shown on the display:

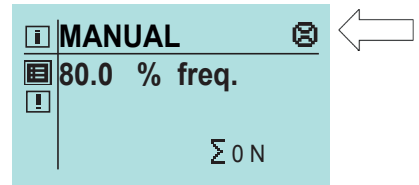

Set dosing monitoring to warning and the number of fault strokes to 1.  
Push ring initiator down as far as the limit stop.  
Switch on the pump.

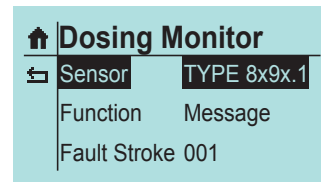

The flow symbol is filled as soon any flow is detected.

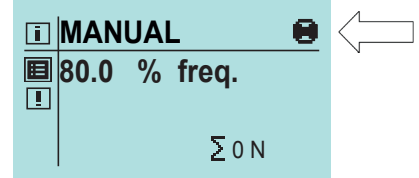

If no flow is detected, the error message „No flow present“ is displayed after executing the specified number of fault strokes. The ring initiator must then be pushed upwards slowly.

#### **i** NOTE

In the case of low stroke frequency or low flow rate, one stroke can take up to five minutes!

After adjustment of the ring initiator, fix this with an O-ring.  
If applicable, acknowledge the error on the display and adjustment of the fault strokes and the function (Stop or Warning) that is executed when no flow is present.

#### **⚠** ATTENTION

The flow monitor must be readjusted in the case of changed operating conditions.

## Diaphragm monitor

Diaphragm rupture detection is installed in every stepper motor pump. It is used for monitoring the delivery diaphragm.

The following items can be adjusted:

### INPUT SIGNAL

Selection between switch off (OFF) of the diaphragm rupture detection and a configuration as NC (Motor pumps "e" and stepper motor pumps) or NO (Motor pumps "ML" and "KM").

### SENSITIVITY

Input of the sensitivity of the diaphragm rupture detection in percent. This enables for pumps with a diaphragm rupture electrode (MBE) adaptation to the conductivity of the pumped medium. In the case of poorly conductive media, the sensitivity must be set to a high value (e.g. 100% at approx. 5 µS/cm).

For ML and KM pumps the sensitivity must not be adjusted.

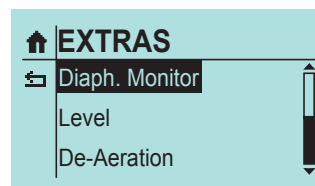

Diaph. Monitor		
Input Signal	OFF →	NC; NO
Sensitivity	050% →	001% ... 100%

## i NOTE

The sensitivity is set to 50% at the factory. This corresponds to a minimum conductivity of the dosing medium of approx. 45 µS/cm. The minimum conductivity at 100% sensitivity is 5 µS/cm.

## Level

The connection of a **sera** suction lance enables the monitoring of the fill level of the dosing tank:

The following items can be adjusted:

- Pre-alarm
- Dry run

Configuration of the two level inputs. It can be selected between either the switch off (OFF) of the input and a configuration as NC (normally closed floating contact) or NO (normally open floating contact).

The factory setting for both level inputs is NO.

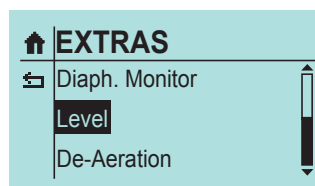

Level		
Pre-Alarm	OFF →	NC; NO
Dry-Running	OFF →	NC; NO

## Configuration of the level input

Configuration	Pre-alarm	Dry run
1	NORMALLY OPEN CONTACT	NORMALLY OPEN CONTACT
2	NORMALLY OPEN CONTACT	NORMALLY CLOSED CONTACT
3	NORMALLY CLOSED CONTACT	NORMALLY CLOSED CONTACT

### Configuration 1

This configuration is preset at the factory. A 1-stage or 2-stage level monitor with floating normally open contacts (pre-alarm + dry run or only dry run) can be connected.

### Configuration 2

This configuration must be selected if a 1-stage level monitor (dry run only) with floating normally closed contact is connected.

### Configuration 3

This configuration must be selected if a 2-stage level monitor with floating normally closed contacts (pre-alarm + dry run) is connected.

## System

Select Settings icon (see arrow).  
Select "System".

The system settings are independent from the operating mode.

- Language
- Display
- SD card
- Time
- Password
- Maintenance
- Data transfer
- Factory setting

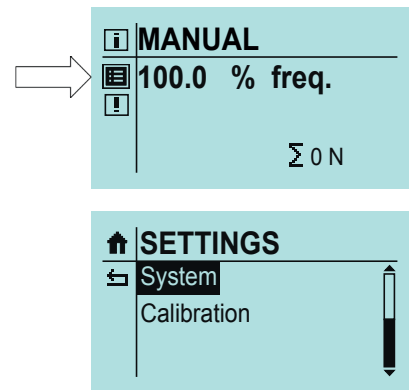

## Language

You can select between 9 languages as menu languages.

- deutsch
- english
- español
- français
- nederlands
- eština
- suomi
- türkçe
- svenska

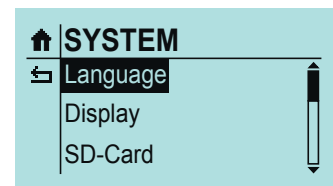

## Display

*Display refresh*  
Cycles of the display refresh

- 1 min
- 30 min
- 1 h
- 10 h
- 24 h

*Contrast*  
0-100%

*Volume unit*  
Display of the units:  
metric  
gal (US)  
l,ml/min

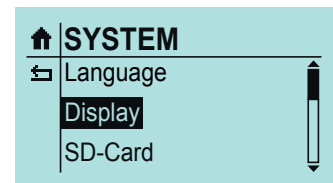

## SD Card

Selection for what should be logged on the SD card.

**Messages**  
If any message occurs, this is logged on the card with the time

**Operating data**  
Delivery quantity, operating mode, settings of INPUTS/OUTPUTS, operating mode dependent data (e.g. analogue current).

**Write period**  
1 min, 5 min, 10 min, 30 min

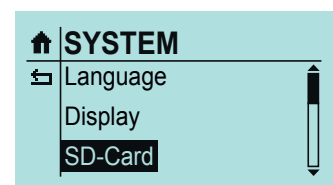

## Time

Setting of date and time.

### Time format

0-24 h

0-12 h am/pm

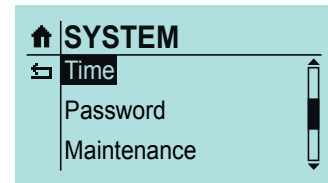

## Password

Two password levels are provided to increase the operating safety. The passwords for these levels consist of a four-digit numeric code and are freely selectable.

Password 1 **9990** (PW1) is used to protect the setting of the delivery quantity (Level 01). This password can be activated and deactivated (when leaving the factory, it is deactivated).

Password 2 **9021** (PW2) is used to protect the setting of the operating mode and the settings of the main value as well as the deletion of messages (Level 02, see "Menu guidance"). This password can be activated and deactivated (when leaving the factory, it is activated).

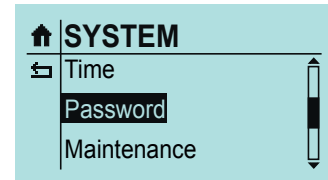

PASSWORD			
←	PW1-Mode	OFF →	ON
	PW2-Mode	ON →	OFF
	Password 1	9990	
	Password 2	9021	

**Maintenance**

After 2500 operating hours, a service message requiring service kit order is shown. After acknowledging the service message, the pump can continue to operate.

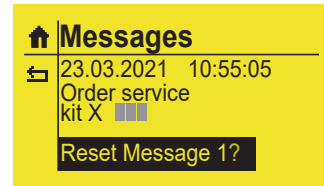

**i NOTE**

After acknowledging the service message is repeated after 48 hours.

After 3000 operating hours, a service message requiring service kit replacement is shown.

After acknowledging the service message, the pump can continue to operate.

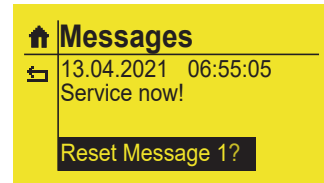

**i NOTE**

If the warning is acknowledged without change, the service message is repeated after 24 hours.

**Change diaphragm**

The diaphragm must be replaced if the Service message occurs. The menu specifies the following procedure for the pump:

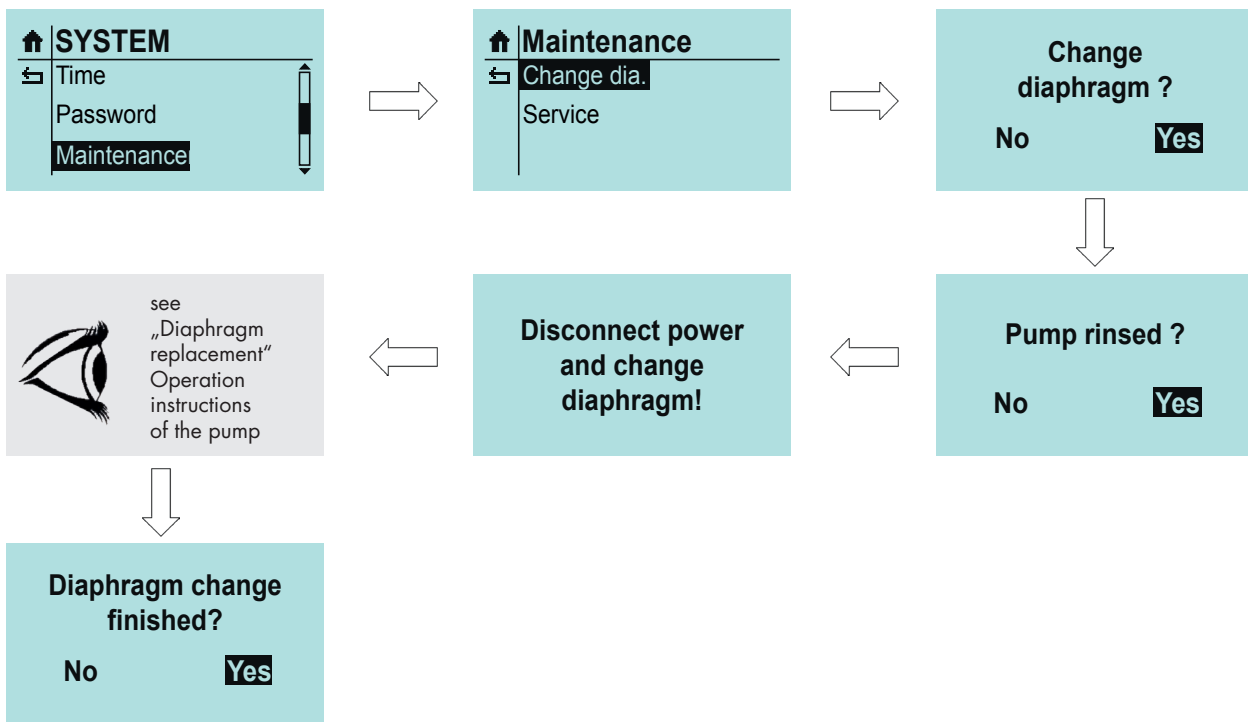

The counters for diaphragm operating hours and diaphragm service life are reset after successful diaphragm replacement.



## Data transfer

### Pump-Display

Data transfer from pump to the display

### Display-Pump

Data transfer from display to the pump

For the data transfer, a pump must be parametrised to the required settings using the control panel.  
Once this is done, the "Pump-Display" data transfer function transfers the parameter settings to the memory in the display.

Data transfer is only possible between pumps with the same displacement mode and flow rate, e.g.  
iSTEP X 20 ► iSTEP X 20  
C409.2- 50e ► C409.2- 50e  
C409.2- 45ML ► C409.2- 45ML

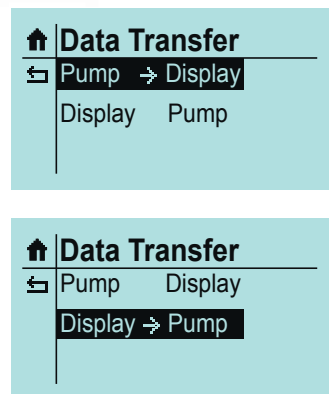
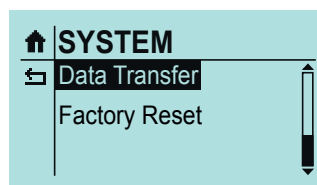
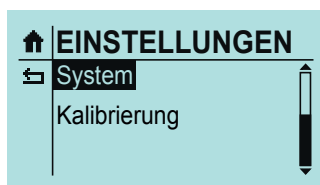

The display can now be unscrewed from the pump and connected to another pump. Using "Display-Pump" data transfer, the parameters stored on the display can be transferred to the second pump. This process can be repeated any number of times with other pumps. After the data transfer calibrate the pump(s).  
The advantage is that each pump does not have to be parametrised individually.

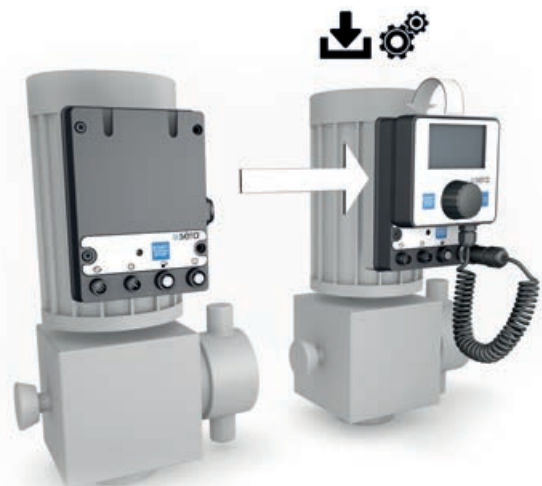

## Factory settings

Restore pump to factory settings (see parameters table for factory settings).

YES must be set and acknowledged for this.

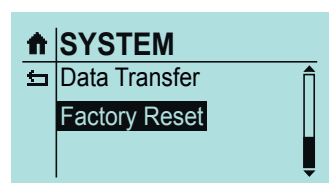

### Calibration of the delivery rate display

The calibration is used to activate the flow rate indicator.  
 Calibration is always done in the same way, no matter whether a flow meter is connected or not.

#### ATTENTION

The correct sensor type must be set (see „Dosing monitor“, page 35) before the calibration with connected flow meter.  
 If no sensor type is set („OFF“), the calibration will only activate the standard flow rate indicator.

### Sequence of calibration

Route the suction line into a calibration pot filled with the dosing medium – the pressure line must be installed in final position, i.e. the pump is operating under operating conditions.  
 The dosing medium must be suctioned if the suction line is empty (operating mode **MANUAL**, let pump run).  
 Note the fill level in the calibration pot (= base quantity).  
 Under **SETTINGS** select the **CALIBRATION** menu item.

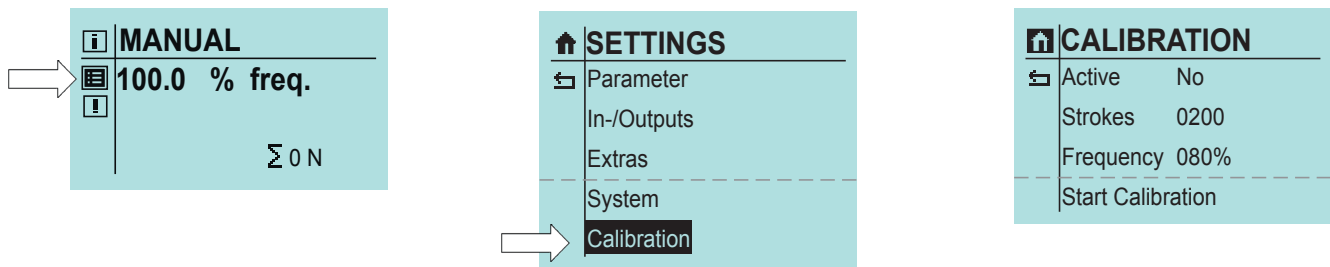

First, enter the required number of strokes (**at least 200!**)  
 the higher the number of strokes, the more accurate is the calibration!  
 Enter **frequency** at which the pump should be operated later (10...100%).  
 Set the **stroke length** (series C409.2) at which the pump is to be operated (20 ... 100%).  
 Select **Start calibration** to start the calibration.  
 The dosing pump performs the specified number of strokes (wait for process).  
 Determination of the delivered quantity (= difference between base quantity and remaining quantity in the calibration pot).  
 Input of the determined delivered quantity (**MEASURED VALUE**).

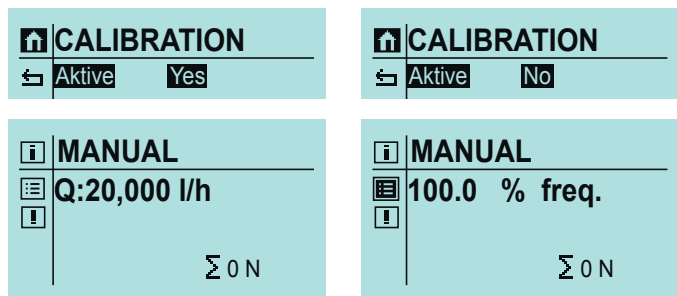

#### NOTE

The value for the „Active“ parameter is automatically set to „Yes“ after the calibration has been performed.  
 This value can now be changed!  
 In the case of pumps of the C409.2 series, if the stroke length deviates by +/- 15% of the calibrated value and below a stroke length of 20%, the warning „Leave calibration range“ is displayed.  
 Below a stroke length of 20%, this warning can be followed by the error message „No stroke detection“.  
 The pump is stopped.

## Standard flow rate indicator

With the standard flow rate indicator, the entered target value is converted to the corresponding stroke frequency.

### Internal calculation:

100% stroke frequency > calibrated: 10 l/h  
Setpoint: 8 l/h > 80% stroke frequency

### Flow rate indicator with flow meter

The flow meter records the actual value, and the motor pump readjusts the flow rate using the stroke frequency as soon as it deviates from the entered setpoint.

The maximum configurable setpoint is limited by the internally determined stroke length (motor pump).

### Example:

If a target value of 8 l/h is entered, the stroke frequency is accordingly first reduced to 80%. The flow meter measures a flow rate of 7.9 l/h. The internal regulation increases the stroke frequency to 81% to reach 8 l/h.

The maximum setpoint in this case is 10 l/h.

### Internal control:

100% stroke frequency > calibrated: 10 l/h	80% stroke frequency > actual value: 7.9 l/h
Setpoint 8 l/h > 80% stroke frequency	8 l/h > 81% stroke frequency

## Effects on the indicators for the different operating modes

### MANUAL operating mode

After calibration of the dosing pump, the delivery rate is entered directly as setpoint in l/h instead of via the stroke frequency adjustment. In the "Operating messages" view, the stroke frequency display is replaced accordingly with the flow rate display. The total dosing volume is also still indicated in litres.

### ANALOGUE operating mode

After calibration of the dosing pump, the delivery rate is entered directly as setpoint in l/h instead of via the stroke frequency adjustment. The calibration of the pump activates the flow rate indicator and the total dosing quantity in litres is also shown.

### BATCH operating mode

After calibration of the dosing pump, the delivery rate is entered directly as setpoint in l/h instead of via the stroke frequency adjustment. After calibration of the pump, the dosing volume and the remaining dosing volume are indicated in litres.

### IMPULSE operating mode

After calibration of the dosing pump, the delivery rate is entered directly as setpoint in l/h instead of via the stroke frequency adjustment. After calibration of the pump, the total dosing volume is also indicated in litres.

### TIMER operating mode

After calibration of the dosing pump, the delivery rate is entered directly as setpoint in l/h instead of via the stroke frequency adjustment.

**Info**

The following information can be recalled:

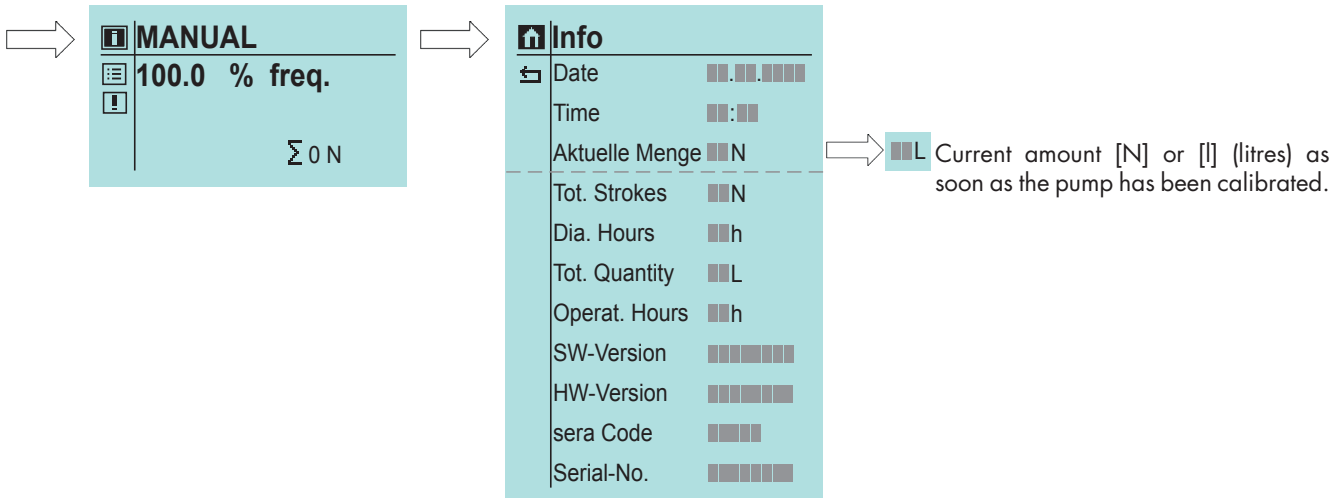

**Messages**

The messages menu function can be reached using a message icon from the operating mode window.

All messages that occur during operation are displayed here in plain text and with date and time of the occurrence.

The displayed messages are in chronological order.

Clicking on the text: Delete message x? deletes the message from the memory. However, this is only possible if the signal is no longer present. For example, if the fault has not been rectified, it is not possible to delete the error and it is written to the memory again.

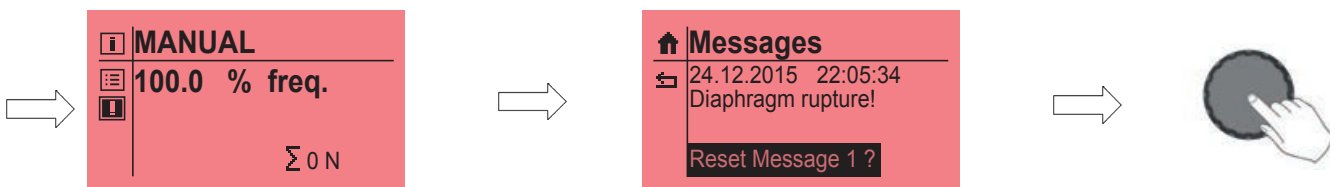

"No messages available" is displayed if no messages are stored.

Any message during operation is shown on the display immediately.

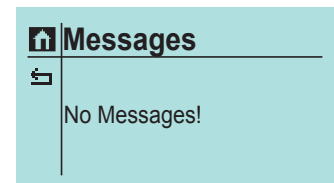

## Settings (parameters)

The following table shows the factory settings for the stepper motor pump. Standard applications such as Manual Mode, Analogue Operation with 4-20 mA and Pulse Operation 1/1 and External Stop are preset.

The references to the respective chapters facilitate the adjustment of the settings. Furthermore, the parameters table provides the possibility to document the changes that have been made in the settings.

### Overview of set parameters

	Factory setting	Page	Change	Change
<b>Pulse operation</b>				
Pulse memory	ON	page 17		
Pulse mode	1:1	page 17		
Pulse factor	1/1	page 17		
<b>Analogue operation</b>				
Signal	4-20 mA	page 20		
<b>Batch operation</b>				
Control	manual	page 22		
Quantity	0 N	page 22		
Frequency	0 %	page 22		
<b>Input 1</b>				
Function E1	Pulse	page 30		
Contact E1	Normally open contact	page 30		
<b>Input 2</b>				
Function E2	External stop	page 31		
Contact E2	Normally open contact	page 31		
<b>Input 3</b>				
Function E3	Analogue 2	page 31		
Contact E3	Normally open contact	page 31		
<b>Output 1</b>				
Function A1	Group fault	page 32		
Contact A1	Normally closed contact	page 32		
<b>Output 2</b>				
Function A2	Stroke signal	page 32		
Contact A2	Normally open contact	page 32		
<b>Analogue output</b>				
Function	Analogue input	page 33		
Signal	-	page 33		
<b>Dosing monitoring</b>				
Sensor	OFF	page 35		
Function	Warning	page 35		

## OPERATION

	Factory setting	Page	Change	Change
<b>Level</b>				
Pre-alarm	Normally open contact	page 37		
Dry run	Normally open contact	page 37		
<b>System</b>				
Language	Deutsch	page 38		
<b>Display</b>				
Display refresh	1 h	page 38		
Contrast	70%	page 38		
Volume unit	metric	page 38		
<b>SD card</b>				
Signals	YES	page 38		
Operating data	YES	page 38		
Write period	5 min	page 38		
<b>Time</b>				
Date	set date	page 39		
Time	set time	page 39		
Format	0-24h	page 39		
<b>Password</b>				
PW01 mode	OFF	page 39		
PW02 mode	ON	page 39		
Password 01	9990	page 39		
Password 02	9021	page 39		
<b>Slow mode (stepper motor pump)</b>				
Suction stroke	100%	page 31		
<b>Speed control (motor pump)</b>				
Mode	Auto	page 34		
<b>Speed limit</b>				
Speed	100%	page 34		
<b>Diaphragm monitoring</b>				
Input signal	Normally open contact	page 37		
Sensitivity	50%	page 37		
<b>Calibration</b>				
Active	NO	page 42		
Strokes	200	page 42		
Speed	80%	page 42		

**sera** products are sophisticated technical products which are only shipped after having been thoroughly tested and checked at our factory. Should there be any faults, these can be detected and rectified easily and quickly based on the error messages in the display and the instructions in the tables.

Warning and error messages										Possible cause	Corrective action	
No flow	Flow rate too low	Pulse memory full	Analogue signal < 4 mA	Analogue signal > 20 mA	Overcurrent control connec./	Analogue signal > 25 mA	Mains voltage too low	Mains voltage too high	Time error	Order wear parts kit		
■	■						■	■			Electrical data of the dosing pump do not match mains data.	Check order data. Check electrical installation.
			■								Broken wire in the analogue signal line.	Check the analogue signal line and repair if necessary.
			■	■							Type of the specified analogue signal (e.g. 4-20 mA) does not match the actual analogue signal (e.g. 0-20 mA).	Check the specified analogue signal and adjust to the actual analogue signal if necessary.
						■					Analogue signal transmitter (sensor, regulator) has a fault.	Check the analogue signal transmitter and correct fault.
		■									Frequency of the incoming pulses is (constantly) higher than the maximum stroke frequency of the dosing pump.	Check process parameters.
		■									Pulse factor too high.	Check process parameters.
										■	Diaphragm has exceeded the maximum service life of one year or the maximum operating hours.	Contact <b>sera</b> and order diaphragm kit.
									■		Defective battery for the power supply of the real-time clock.	Contact <b>sera</b> .
					■						Overcurrent at digital outputs or at the 24 V output of the control connection.	Check load on the outputs. Eliminate overcurrent or short circuit. Reset error by disconnecting the pump from the mains for at least 60 seconds.

## FAULT ANALYSIS / FAULT CORRECTION

Warning and error messages								Possible cause	Corrective action		
Motor overtemperature!	Diaphragm rupture!	No flow!	Flow rate too low!	Pre-alarm level!	Dry running dosing pump!	No stroke detection!	Fault drive 1! (Warning)	Fault drive 2! (Error)	Setpoint not achievable		
■	■	■								Defective drive diaphragm.	Replace drive diaphragm.
		■	■				■	■		Suction height too high.	Reduce suction height or suction resistance.
		■	■							Suction pipe leaking.	Check seals, tighten pipe connections.
		■	■				■			shut-off valves in piping closed.	Open shut-off valves or check opening state – check pump for possible damage.
		■	■	■	■					Medium level in storage tank too low or no medium.	Fill storage tank.
		■	■							Pump valves leaking.	Remove and clean valves.
		■	■							Pump valves (ball seats) damaged.	Remove and clean valves, check function; replace valves if necessary.
		■	■							Pump valves incorrectly installed or valve balls missing.	Check installation position and completeness – replace missing parts or install correctly.
		■	■				■	■		Filter in suction line clogged.	Clean filter.
		■	■			■	■	■		Backpressure too high.	Measure pressure with manometer directly above pressure valve if possible and compare with permissible backpressure.
		■	■							Foreign matter in the pump valves.	Remove and clean valves.
		■	■				■	■		Acceleration height too high due to pipe geometry.	Check acceleration height on suction and pressure sides with manometer and compare with design data – install a pulsation damper if necessary.
		■	■			■	■	■		Viscosity of the pumped medium too high.	Check viscosity of the pumped medium and compare with design data – reduce concentration or increase temperature if necessary or install other pump valves.
		■	■							Pumped medium is outgassing in the suction pipe and/or the pump body.	Check geodetic conditions and compare with data of the pumped medium. Operate pump with suction side supply, reduce temperature of the pumped medium.
		■	■							Air in suction line while pressure is present on the pressure side.	Vent pressure side or open vent valve.
■		■	■							Reversible thermal fuse of the pump has tripped.	Let temperature of the pump cool down. Check ambient temperature.
		■	■							Pipe connections leaking.	Tighten connections according to type of material. Be careful with plastic – risk of fracture!
		■	■			■	■			Pumped medium frozen in pipe.	Remove pump and check for possible damage - increase temperature of the pumped medium.
		■	■							Pump valves dry.	Moisten pump body and valves. Open vent valve.
						■	■	■		Sensors of the dosing pump defective.	Contact <b>sera</b> .
						■				Stroke length is <20% for pumps in the C409.2 series	Set a longer stroke length. Flow rate adjustment by reducing the stroke frequency.
									■	Calibrated delivery rate not achievable with current setting e.g. stroke length too short.	Check stroke length.





## WARNING

Observe and follow the safety instructions by all means.  
See the additional instructions „SAFETY INSTRUCTIONS“.  
Man, machine and environment are endangered if the safety instructions are not observed.



### **Maintenance and cleaning**

The manual control is maintenance-free. Clean with a moist cloth. Rub dry afterwards.

### **Decommissioning**

Disconnect device from the power supply.  
Detach electrical connections.  
Take device out of operation.

### **Disposal**

Dispose of correctly and comply with the currently applicable local regulations after shutdown and dismantling.

**i NOTE**

The parameter settings that were made on the pump are retained after the software update.

- Install the Atmel **Flip program** (included in the installation package) on your PC or notebook (if not already done).
- For this purpose execute the „**Flip Installer – 3.4.7.112.exe**“ file and follow the on-screen instructions.
- Disconnect pump from the power supply and loosen connection of the operator display.
- Connect the USB-M12 adapter to the PC or notebook.
- Connect the USM-M12 adapter to the display connection of the pump.
- Hold the ON/OFF button and switch on the power supply of the pump again.
- The status LED of the pump lights yellow.
- The pump is now in the Update mode.
- A message for installation of the device driver appears on the screen of the PC/notebook (if this has not already happened).



Upon completion of the installation the device can be used.

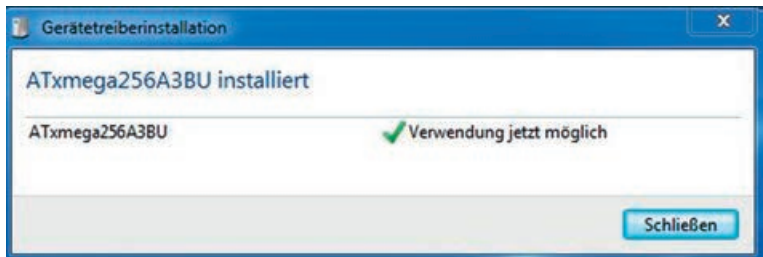

The device (1) which has been installed is now available in the Device Manager of the PC/notebook.



Store the folder with the "USB-Update vM01.00X" update files on the drive where the installation of Atmel FLIP was saved. Start the "USB\_run\_vM01.00X.bat" batch file in the folder by double-clicking it. An MS-DOS command window now opens showing the progress of the installation. The successful completion of the updates is shown as follows.

```
ATXMEGA256A3BU - USB - USB/DFU

Device selection..... PASS
Hardware selection..... PASS
Opening port..... PASS
Reading Bootloader version..... PASS      1.0.4
Parsing HEX file..... PASS      vM01.003.hex
Programming memory..... PASS      0x000000 0x2ab06
Starting Application..... PASS      RESET  0x00

Summary: Total 7 Passed 7 Failed 0

C:\Users\sit\Desktop\USB-Update vM01.003>REM goto Warten

C:\Users\sit\Desktop\USB-Update vM01.003>pause
Drücken Sie eine beliebige Taste . . .
```

The update is now finished.  
The pump restarts automatically.  
Disconnect the USB-M12 adapter from the pump and reconnect the display.  
The pump is ready for operation.

FOLLOW US



**sera GmbH**  
sera-Str. 1  
34376 Immenhausen  
Germany  
Tel. +49 5673 999 00  
Fax +49 5673 999 01  
info@sera-web.com