

INDUSTRIAL CLEANING TECHNOLOGY



CONTINUOUS
OPERATION IS
OUR STANDARD!

INSPIRED. SOLUTIONS. FOR CUSTOMERS.

The image shows a low-angle shot of a modern building with a glass and metal facade. The sun is shining brightly from the left, creating a lens flare effect. The Sera logo, consisting of a stylized blue and white 'S' icon followed by the word 'sera' in lowercase black letters, is mounted on the building's exterior. A semi-transparent blue rectangular box is overlaid on the lower half of the image, containing white text.

CONTINUOUS OPERATION IS OUR STANDARD

sera supplies high-pressure pumps and high-pressure pump units for a wide range of applications in which liquids have to be conveyed at high pressure. Triplex plunger pumps, which belong to the category of positive or oscillating displacement pumps, are mainly used for this purpose.

Other specifications and modes of operation of the pumps can of course be selected at the customer's request.

CUSTOMISED SOLUTIONS

CLEANING OF TANKS AND TANKERS

Here, the combination of individually combinable high-pressure units with tank washing heads that are suitable for the respective requirements provides an **All-in-One solution** for the most diverse applications.

- Cleaning of tankers (lorries and rail)
- Tank cleaning
- Food and drinks industry
- Pharmaceutical and chemical industries
- Waste management

ADVANTAGES

- Better cleaning results
- Reduced cleaning time
- Reduced water consumption
- Reduced use of chemicals

One huge advantage is the combination of robust high-pressure units designed for continuous operation; these are equipped with the required cleaning heads and the right dosing technology for the use of chemicals.

This allows us to develop and deliver a complete package that provides everything our customers require, from water tapping points to spray nozzles.



CUSTOMISED SOLUTIONS

EVAPORATIVE COOLING

When one litre of water evaporates, it removes 630 W of heat energy from the ambient air. For evaporation to take place, very fine water droplets must be produced by means of a high-pressure atomisation process. Water atomised by high pressure evaporates 850 times faster because the water surface is increased by two million times. Enthalpy control atomises only as much water as the air can actually absorb.

- No water precipitation
- No condensate formation
- Everything stays dry!

We design these types of cooling systems individually according to the respective customer requirements, and manufacture them specifically for these requirements.

SAMPLE APPLICATIONS

- Adiabatic industrial cooling
- Condensation cooling
- Ambient air cooling
- Atomisation units
- and much more.



CUSTOMISED SOLUTIONS

ALL-IN-ONE SOLUTION - EVERYTHING FROM A SINGLE SOURCE!

However, our options and applications cover more than the above-mentioned areas – we also offer customised products. In other words:

„We manufacture units or complete systems entirely according to your requirements!“

SAMPLE APPLICATIONS

- Washing systems
- Reverse osmosis
- Chemical processes
- Water hydraulics
- Food processing
- and much more.

You have the option of determining how the different units are to be arranged, and also the type of power transmission:

- Direct drive (with pump carrier)
- Gear boxes
- Belt drives

Of course, you also have the option of developing a complete solution according to your individual preferences and requirements.

Thanks to our extensive expertise in both high-pressure technology and dosing technology, we offer the option of an **All-in-One solution** individually adapted to your requirements – and **all this from a single source!**



HIGH-PRESSURE PUMPS

FOR CONTINUOUS OPERATION

sera supplies high-pressure pumps and high-pressure pump units for a wide range of applications in which liquids have to be pumped at high pressure. Triplex plunger pumps, which belong to the category of positive or oscillating positive displacement pumps, are mainly used for this purpose. Other pump specifications and modes of operation can of course be selected according to our customers' requirements.

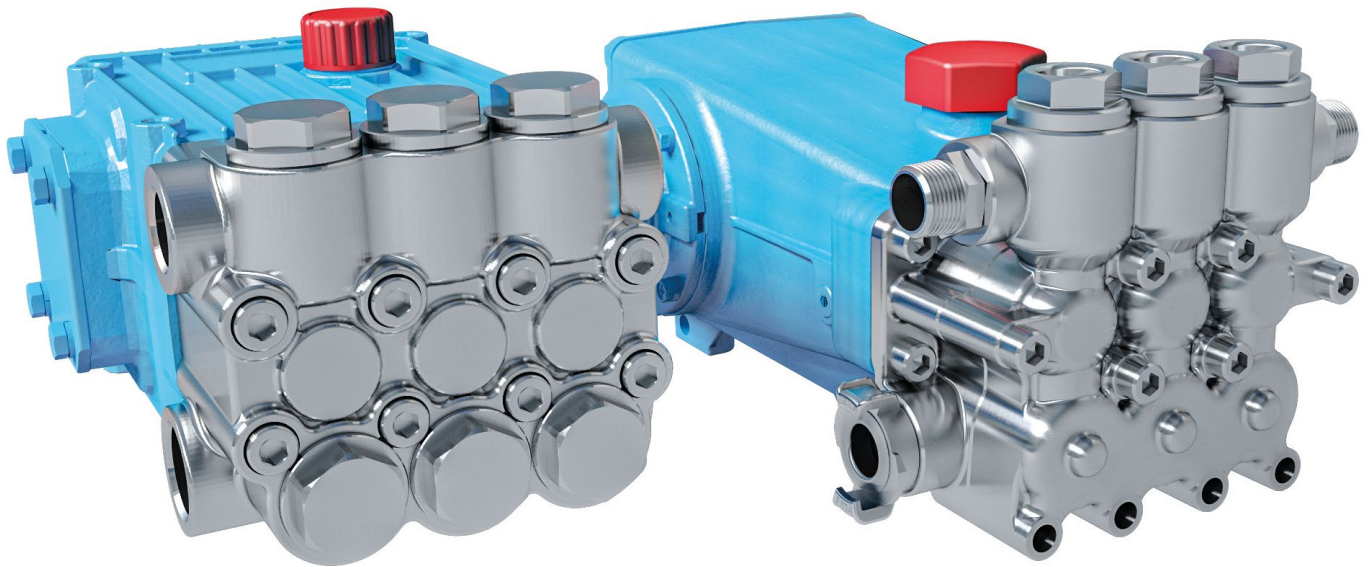

ADDITIONAL PRODUCT RANGE

- Complete accessories for high-pressure cleaning (valves, hoses, spray guns, spraying pipes, etc.)
- Nozzle technology for a wide range of applications
- Tank cleaning heads for cleaning the interior of tanks
- Dosing technology for washing chemicals

ADVANTAGES AT A GLANCE

- 3 plungers made of resistant ceramic
- High-grade materials
- Linear control characteristics
- Low maintenance
- Low operating costs
- Easy to use
- Design available in accordance with ATEX
- Seals available in accordance with FDA

TECHNICAL DATA

- Delivery rate up to 900 l/min
- Operating pressure up to 1000 bar
- Temperatures -23 °C ... +116 °C

HIGH-PRESSURE UNITS

FOR HIGH-PRESSURE APPLICATIONS

The high-pressure technology that we provide covers a wide range of applications, and, of course, we want to provide solutions that are ideally suited to our customers' requirements.



PUMPS – MOTORS – UNITS

The basic configuration, on which all further units are developed, consists of a motor and a robust and durable pump. This unit can be assembled or fixed by the customer as required.

UNITS WITHOUT CONTROL SYSTEM

Adding a frame to the pump motor unit makes it easy to set up the unit. Thanks to the modular principle, it is possible to arrange several units into a space-saving combination.

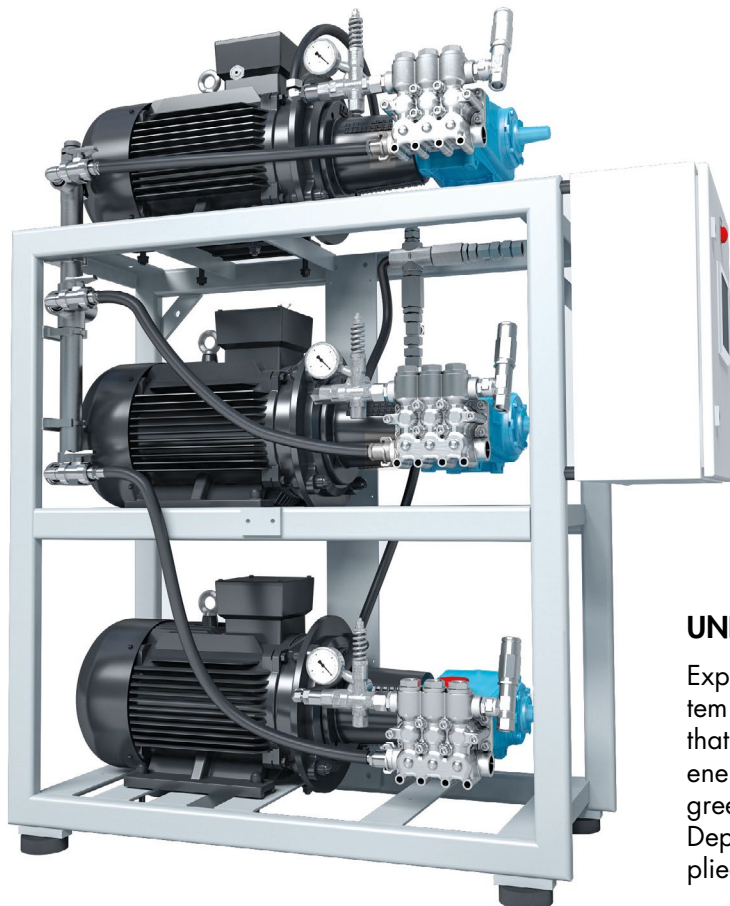
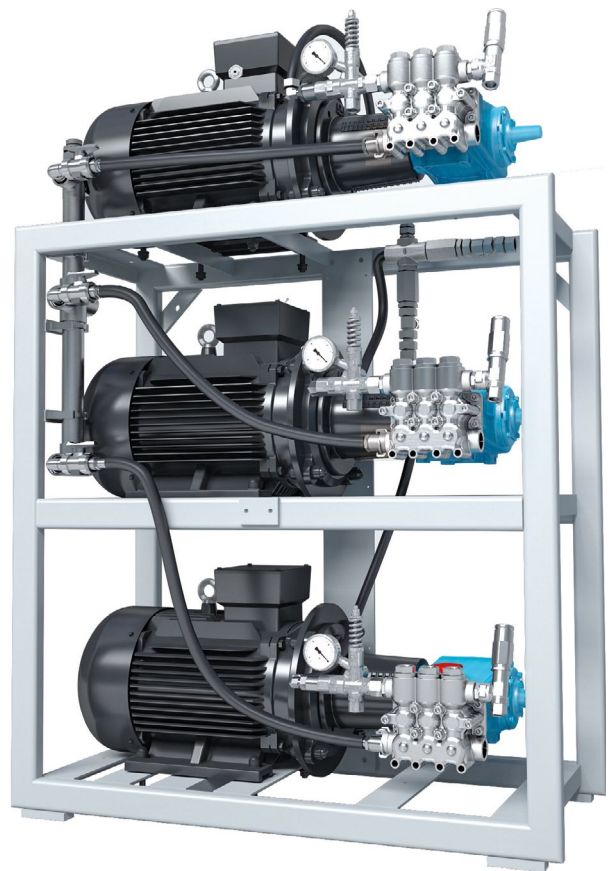

UNITS WITH CONTROL SYSTEM

Expansion of the unit in the (cube) frame by a control system enables demand-orientated control. This control ensures that the required performance is achieved with minimum energy and water consumption, while ensuring a high degree of efficiency and a long service life. Depending on customer requirements, this unit can be supplied with frequency control or cascade control.

HIGH-PRESSURE SYSTEMS

ENERGY-EFFICIENT SYSTEMS WITH HIGH EFFICIENCY

The energy-efficient high-pressure system from **sera** was developed for the use of several hand lances, tank washing heads or other consumers in the high-pressure range up to 500 bar. To achieve the highest possible efficiency, **sera** offers these machines with a pressure-dependent demand control. This control enables the targeted delivery of the water quantity that is demanded by the consumer in each case, whether by a single pump unit or by several pump units. The preset pressure always remains constant.

Depending on how many consumers are in use, the delivery rate is regulated upwards or downwards via the frequency converter. The use of this pressure-dependent demand control reduces both water and energy consumption. Bypass operation, which causes wear, is avoided and the service life of high-pressure pumps and control valves is considerably longer.

In case of pressure drop, e.g. due to wear of the nozzles at the tank washing head, the speed of the machine is automatically adjusted and thus the nozzle wear is compensated for some time. **sera** only uses energy-efficient IE4 motors for these systems. The significantly lower consumption of energy and wearing parts ensures that the system pays for itself quickly.

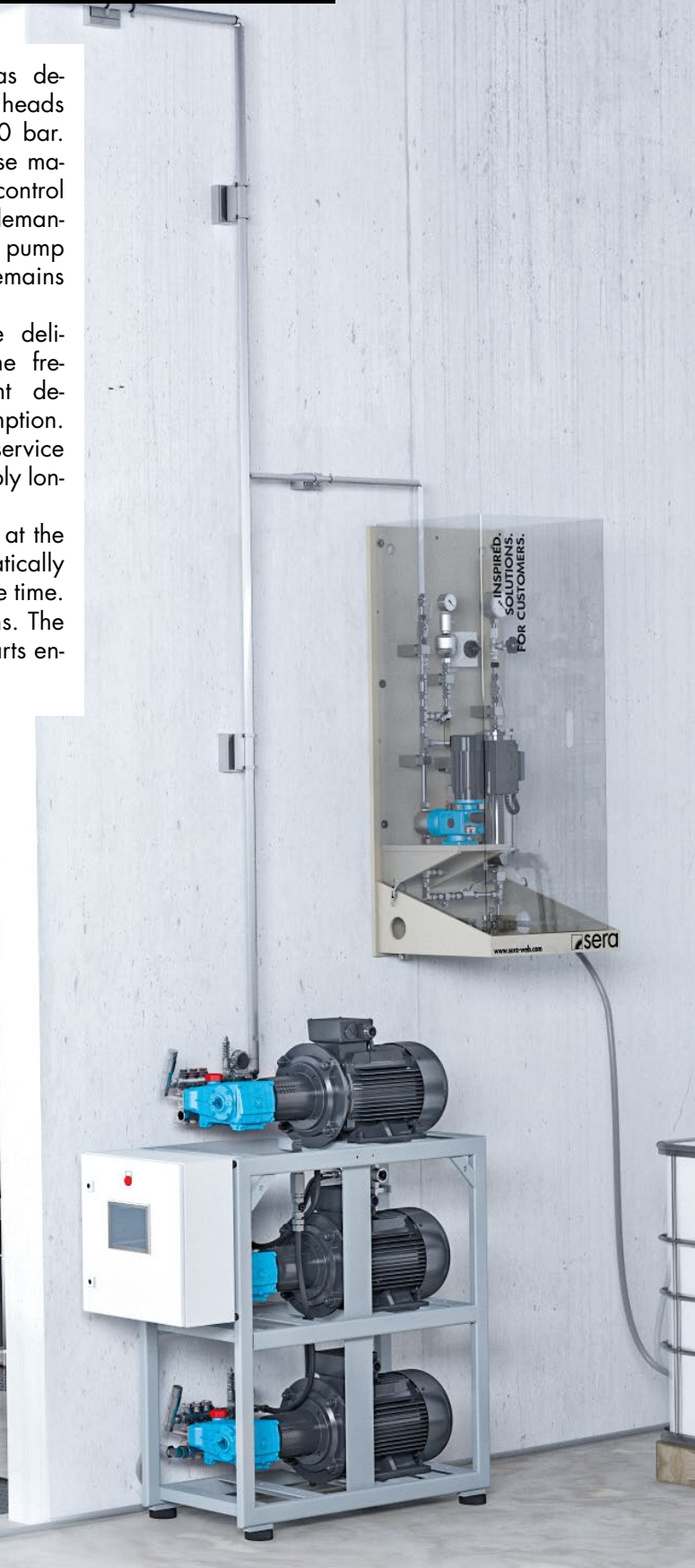

HIGH-PRESSURE CLEANER

STATIONARY (HPCcenter) OR MOBILE (HPCmove)

This unit has been designed for commercial use. The device is a compact model that is particularly space-saving and completely ready for connection with its integrated electrical control system. The high-pressure pump unit can be operated with either fresh water or service water.

DESCRIPTION OF FUNCTION

When the pressure drops (by actuating the spray gun), the device automatically switches on. When the spray gun is closed, the device switches to standby mode after a delay of 3 to 30 seconds (adjustable), and starts up again immediately when the spray gun is actuated. If the water supply is interrupted, the device will not switch on, thus safeguarding against dry running (does not apply to operating without feeding pressure).

HIGH-PRESSURE PUMP

- Pump head corrosion-resistant brass, NiAlBr, stainless steel, duplex and other special materials
- Hard ceramic plunger (solid)
- Valves, valve seats and springs in stainless steel
- Seals made of special material
- Integrated leakage return
- Silent operation
- Cast aluminium crank housing
- Forged crankshaft made of CrMo steel

TECHNICAL DATA

- Delivery rate*: 15 l/min
- Operating pressure*: 200 bar
- Speed: 1,450 rpm
- Motor power: 5.5 kW

*Other delivery rates and operating pressures on request.

ADVANTAGES AT A GLANCE

- Standardised pre-washing devices
- Compact design
- Integrated control
- Suitable for fresh and process water



ADDITIONAL OPTIONS

FOR HIGH-PRESSURE CLEANER

Individual customer requirements can thus be fulfilled in combination with our extensive range of accessories.

WE CAN OFFER:

- Spray nozzles & cleaning accessories
- Spray guns, spraying pipes & spray jet pipes
- High-pressure hoses
- Hose reels
- Valves, fittings & screw connections
- and much more.



TANK CLEANING HEADS

FOR INTERNAL TANK CLEANING

sera supplies tank cleaning heads specially designed for internal tank cleaning. The tank cleaning heads are ideally matched to the high-pressure pumps used and are driven both with water or with electric motor. Tank cleaning heads fitted with **sera** nozzles ensure an ideal cleaning result. The tank cleaning heads are also approved for potentially explosive atmospheres (according to ATEX).

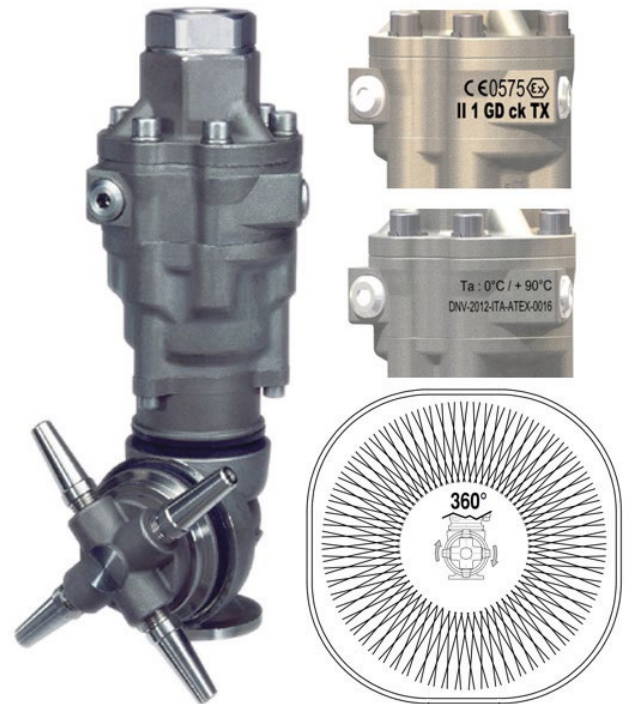

NOZZLE TECHNOLOGY

HIGH-QUALITY SPRAY NOZZLE HEADS AND TANK WASHING HEADS

YOUR CONTACT FOR ENGINEERING SERVICES

We are a reliable partner, offering high-quality spray nozzles and tank washing heads; we are your professional contact for engineering services.

Coordination of the individual components, from the pump to the nozzle, is extremely important in terms of process technology. We provide complete pump-spray nozzle solutions and deliver everything from a single source thanks our own control system design. Every system undergoes a 100 % check on the test stand and a functional test. We supply replacement nozzles for all reputable nozzle manufacturers and guarantee perfect operation of the existing system.

SAMPLE APPLICATIONS

The high quality of the materials guarantees long-term, operationally reliable use. The right material is available to meet every need.

- Steel industry
- Food industry
- Drinks industry
- Pharmaceutical industry
- Chemical industry
- Paper and cellulose industry
- Oil, gas and petrochemicals
- (Exhaust) gas scrubbing and cleaning
- Surface technology
- Dust control
- Emissions protection
- (Waste) water treatment
- Agricultural industry
- Textile and leather industries
- Mining



PRODUCT RANGE

FULL CONE NOZZLES

- Two-piece spray nozzles
- Grooved rim
- Flange socket
- S insert
- Without insert – off-line
- X insert / round steel / two-piece or three-piece / high flow values
- X insert / square spray pattern / two-part or three-part
- X insert / small spray angle – injection nozzles

TANK CLEANING NOZZLES/TANK WASHING HEADS

- Fixed spray heads
- Single-axis heads – reaction drive
- Single-axis heads – motor drive
- Small washing heads
- Positive drive
- High pressure with external drive
- Low-pressure and high-pressure turbine models
- Testing/evaluation of the cleaning quality

VENTURI NOZZLES

- Venturi nozzles/mixing injectors

AIR NOZZLES

- Blowing nozzles
- Blowing strips

HIGH-PRESSURE NOZZLES

FULL JET NOZZLES

- Low-pressure and high pressure full jet nozzles

PNEUMATIC ATOMISER NOZZLES

- Ultrasonic atomiser
- Conventional atomiser

HOLLOW CONE NOZZLES

- Turbulence nozzles, tangential
- Turbulence nozzles, axial, row spraying
- Impact nozzles, axial, row spraying

FLAT SPRAY NOZZLES

- Full spray nozzles/flat spray nozzles

SPRAYING PIPES/NOZZLE BARS



PRESSURE TEST DEVICES

COMPACT DESIGN

These devices are standardised and specially designed for commercial use on construction sites. The unit has a compact and space-saving design, but is still clearly arranged and delivered ready for connection.

We can also provide you with pressure test devices with other pressure levels on request. If required, our devices can also be supplied fully automated with pressure presetting. Devices also available in accordance with ATEX.

Type	Delivery rate [l/min]	Pressure [bar]	Power [kW]	Voltage [V]	Weight [kg]
DP-45-100	4,5	100	1,1	230	52
DP-90-100	9	100	2,2	230	52
DP-55-200	5,5	200	2,2	400	62
DP-55-250	5,5	250	3	400	63



EFFICIENT SERVICE

From planning and commissioning of systems to a fast and uncomplicated worldwide equipment replacement service, **sera** provides support in all project phases. In accordance with the company's guiding principle "We create added value for people and the environment", it is always the objective of the **sera Group** to create sustainable and reliable solutions for the customer and to achieve optimum production results. This requires a high availability of the system with a minimum of downtimes. For this purpose, **sera** provides a wide range of services from technical support to spare parts service and repair service.

YOUR CONTACTS

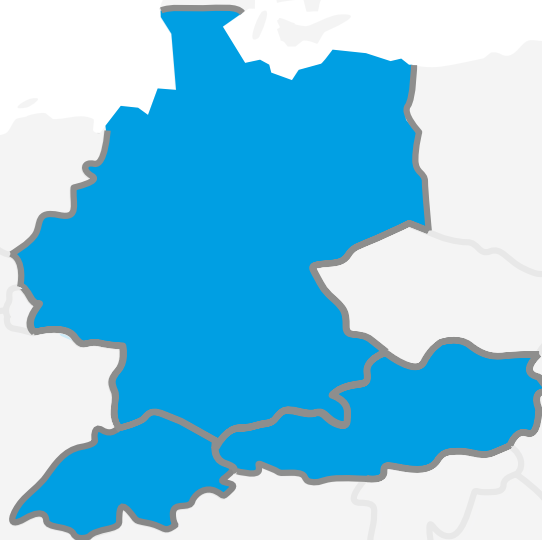

sera ProDos GmbH

sera-Straße 1
D-34376 Immenhausen
Germany

Tel. +49 (0) 5673 999-02
sales.prodos@sera-web.com

sera Technology Austria GmbH

Gewerbestraße 5
A-4774 St. Marienkirchen bei Schärding
Austria

Tel. +43 (0) 7711 31777-0
sales.at@sera-web.com

sera Technology Swiss GmbH

Altenmattweg 5
CH-4144 Arlesheim
Switzerland

Tel. +41 (0) 61 51142-60
sales.ch@sera-web.com

Fixed, competent **sera** contact persons throughout the entire quotation, order and project realisation process guarantee you optimum customer support and advice. Your contact person reacts flexibly to your needs and is fast and reliable in processing and handling. From Engineering to Production to After Sales Service, **sera** provides you with high quality products and services.

FOLLOW US

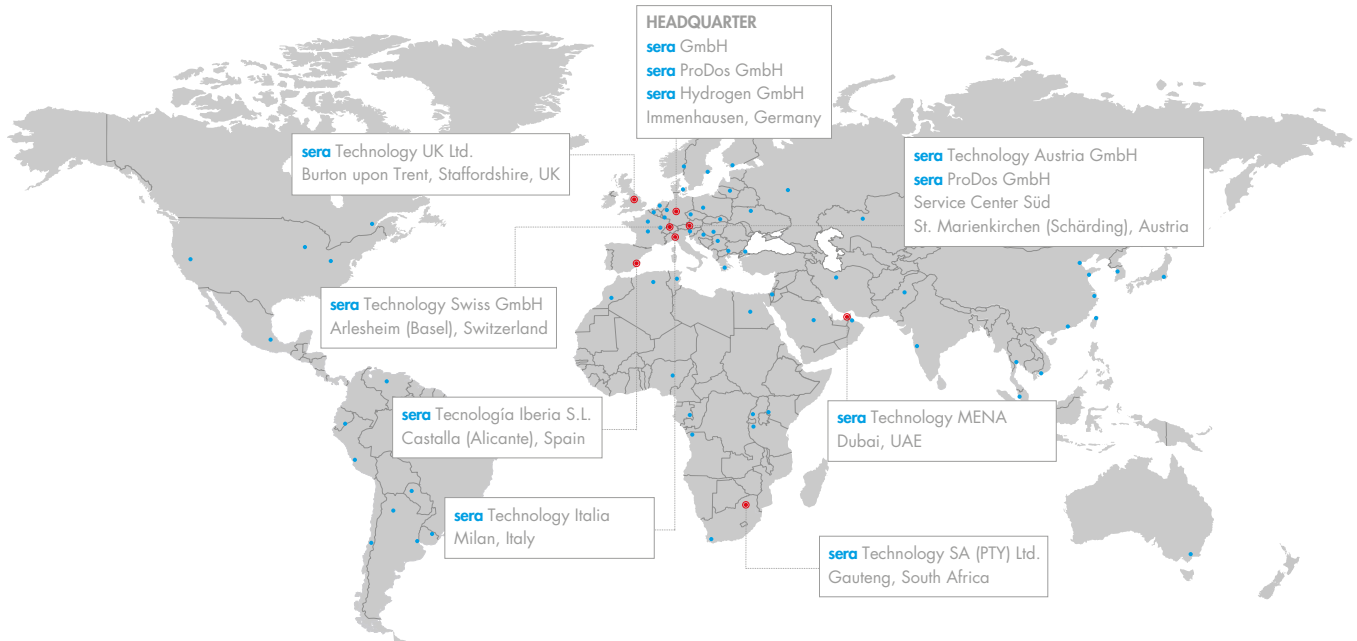

WORKING FOR YOU ALL OVER THE WORLD

sera GmbH

sera-Straße 1
34376 Immenhausen
Germany

Tel.: +49 5673 999-02

info@sera-web.com

sera ProDos GmbH

sera-Straße 1
34376 Immenhausen
Germany

Tel.: +49 5673 999-02

sales.prodos@sera-web.com

sera Hydrogen GmbH

sera-Straße 1
34376 Immenhausen
Germany

Tel.: +49 5673 999-04

sales.hydrogen@sera-web.com

sera ProDos GmbH Service Center Süd

Gewerbestraße 5
4774 St. Marienkirchen bei Schärding
Austria

Tel.: +49 5673 999-02

sales.prodos@sera-web.com

sera Technology Austria GmbH

Gewerbestraße 5
4774 St. Marienkirchen bei Schärding
Austria

Tel.: +43 771 131 7770

sales.at@sera-web.com

sera Technology Swiss GmbH

Altenmattweg 5
4144 Arlesheim
Switzerland

Tel.: +41 615 114 260

sales.ch@sera-web.com

sera Technology UK Ltd.

Unit 5, Granary Wharf Business Park
Wetmore Road, Burton upon Trent
Staffordshire DE14 1DU
United Kingdom

Tel.: +44 1283 753 400

sales.uk@sera-web.com

sera Technology SA (PTY) Ltd.

Unit 3-4, Airborne Park
Cnr Empire & Taljaard Str Bartletts
Boksburg, 1459 Gauteng
South Africa

Tel.: +27 113 975 120

sales.za@sera-web.com

sera Tecnología Iberia S.L.

Calle Cocentaina nº8,
03420 Castalla
(Alicante)
Spain

Tel: +34 666 024 388

sales.es@sera-web.com

sera Technology Italia

Milan
Italy

Tel.: +39 340 81 92 744

sales.it@sera-web.com

sera Technology MENA

Dubai
UAE

Tel.: +971 589 287 559

sales.mena@sera-web.com

www.sera-web.com

